



Fast Recovery Diodes (Stud Version), 6 A, 12 A



DO-4 (DO-203AA)

FEATURES

- Short reverse recovery time
- Low stored charge
- Wide current range
- Excellent surge capabilities
- Standard JEDEC® types
- Stud cathode and stud anode versions
- Fully characterized reverse recovery conditions
- Material categorization: for definitions of compliance please see www.vishay.com/doc?99912



RoHS COMPLIANT

TYPICAL APPLICATIONS

- DC power supplies
- Inverters
- Converters
- Choppers
- Ultrasonic systems
- Freewheeling diodes

PRIMARY CHARACTERISTICS	
$I_{F(AV)}$	6 A, 12 A
Package	DO-4 (DO-203AA)
Circuit configuration	Single

MAJOR RATINGS AND CHARACTERISTICS				
SYMBOL	TEST CONDITIONS	1N3879(R) TO 1N3883(R)	1N3889(R) TO 1N3893(R)	UNITS
$I_{F(AV)}$		6 ⁽¹⁾	12 ⁽¹⁾	A
	T_C maximum	100	100	°C
$I_{F(RMS)}$		9.5	19	A
I_{FSM}	50 Hz	72	145	A
	60 Hz	75 ⁽¹⁾	150 ⁽¹⁾	
I^2t	50 Hz	26	103	A ² s
	60 Hz	23	94	
$I^2\sqrt{t}$		363	856	$I^2\sqrt{s}$
V_{RRM}	Range	50 to 400 ⁽¹⁾	50 to 400 ⁽¹⁾	V
t_{rr}		See Recovery Characteristics table	See Recovery Characteristics table	ns
T_J	Range	-65 to +150	-65 to +150	°C

Note

⁽¹⁾ JEDEC® registered values



ELECTRICAL SPECIFICATIONS

VOLTAGE RATINGS						
TYPE NUMBER	VOLTAGE CODE	V _{RRM} , MAXIMUM REPETITIVE PEAK AND OFF-STATE VOLTAGE V	V _{RSM} , MAXIMUM NON-REPETITIVE PEAK VOLTAGE V	I _{RRM} MAXIMUM AT T _J = 25 °C µA	I _{RRM} MAXIMUM AT T _J = 100 °C mA	I _{RRM} MAXIMUM AT T _J = 150 °C mA
1N3879(R)	-	50	75	15 ⁽¹⁾	1.0 ⁽¹⁾	3.0 ⁽¹⁾
1N3880(R)		100	150			
1N3881(R)		200	250			
1N3882(R)		300	350			
1N3883(R)		400	450			
1N3889(R)	-	50	75	25 ⁽¹⁾	3.0 ⁽¹⁾	5.0 ⁽¹⁾
1N3890(R)		100	150			
1N3891(R)		200	250			
1N3892(R)		300	350			
1N3893(R)		400	450			

Note

⁽¹⁾ JEDEC® registered values

FORWARD CONDUCTION							
PARAMETER	SYMBOL	TEST CONDITIONS			1N3879(R) TO 1N3883(R)	1N3889(R) TO 1N3893(R)	UNITS
Maximum average forward current at case temperature	I _{F(AV)}	180° conduction, half sine wave DC			6 ⁽¹⁾	12 ⁽¹⁾	A
					100	100	°C
Maximum RMS current	I _{F(RMS)}				9.5	19	
Maximum peak, one-cycle non-repetitive forward current	I _{FSM}	t = 10 ms	No voltage reapplied	Sinusoidal half wave, initial T _J = 150 °C	85	170	A
		t = 8.3 ms			90	180	
		t = 10 ms	100 % V _{RRM} reapplied		72	145	
		t = 8.3 ms			75 ⁽¹⁾	150 ⁽¹⁾	
Maximum I ² t for fusing	I ² t	t = 10 ms	No voltage reapplied		36	145	A ² s
		t = 8.3 ms			33	130	
		t = 10 ms	100 % V _{RRM} reapplied		26	103	
		t = 8.3 ms			23	94	
Maximum I ² √t for fusing	I ² √t	t = 0.1 ms to 10 ms, no voltage reapplied			363	1452	A ² √s
Maximum forward voltage drop	V _{FM}	T _J = 25 °C; I _F = Rated I _{F(AV)} (DC)			1.4 ⁽¹⁾	1.4 ⁽¹⁾	V
		T _C = 100 °C; I _{FM} = π x rated I _{F(AV)}			1.5 ⁽¹⁾	1.5 ⁽¹⁾	

Note

⁽¹⁾ JEDEC® registered values

RECOVERY CHARACTERISTICS						
PARAMETER	SYMBOL	TEST CONDITIONS	1N3879(R) TO 1N3883(R)	1N3889(R) TO 1N3893(R)	UNITS	
Maximum reverse recovery time	t _{rr}	T _J = 25 °C, I _F = 1 A to V _R = 30 V, di _F /dt = 100 A/µs	150	150	ns	
		T _J = 25 °C, di _F /dt = 25 A/µs, I _{FM} = π x rated I _{F(AV)}	300 ⁽¹⁾	300 ⁽¹⁾		
Maximum peak recovery current	I _{RM(REC)}	I _{FM} = π x rated I _{F(AV)}	4 ⁽¹⁾	5 ⁽¹⁾	-	
Maximum reverse recovery charge	Q _{rr}	T _J = 25 °C, I _F = 1 A to V _R = 30 V, di _F /dt = 100 A/µs	400	350	nC	
		T _J = 25 °C, di _F /dt = 25 A/µs, I _{FM} = π x rated I _{F(AV)}	400	400		

Note

⁽¹⁾ JEDEC® registered values



THERMAL AND MECHANICAL SPECIFICATIONS					
PARAMETER	SYMBOL	TEST CONDITIONS	1N3879(R) TO 1N3883(R)	1N3889(R) TO 1N3893(R)	UNITS
Maximum junction operating temperature range	T_J		-65 to +150		°C
Maximum storage temperature range	T_{Stg}		-65 to +175		
Maximum thermal resistance, junction to case	R_{thJC}	DC operation	2.5	2.0	°C/W
Maximum thermal resistance, case to heatsink	R_{thCS}	Mounting surface, smooth, flat and greased	0.5		
Allowable mounting torque		Not lubricated threads	1.5 +0 - 10 % (13)		N · m (lbf · in)
		Lubricated threads	1.2 +0 - 10 % (10)		
Approximate weight			7		g
			0.25		oz.
Case style		JEDEC®	DO-4 (DO-203AA)		

ΔR_{thJC} CONDUCTION						
CONDUCTION ANGLE	1N3879(R) TO 1N3883(R)	1N3889(R) TO 1N3893(R)	1N3879(R) TO 1N3883(R)	1N3889(R) TO 1N3893(R)	TEST CONDITIONS	UNITS
	SINUSOIDAL CONDUCTION		RECTANGULAR CONDUCTION			
180°	0.58	0.46	0.33	0.26	$T_J = 150\text{ °C}$	K/W
120°	0.60	0.48	0.58	0.46		
60°	1.28	1.02	1.28	1.02		
30°	2.20	1.76	2.20	1.76		

Note

- The table above shows the increment of thermal resistance R_{thJC} when devices operate at different conduction angles than DC

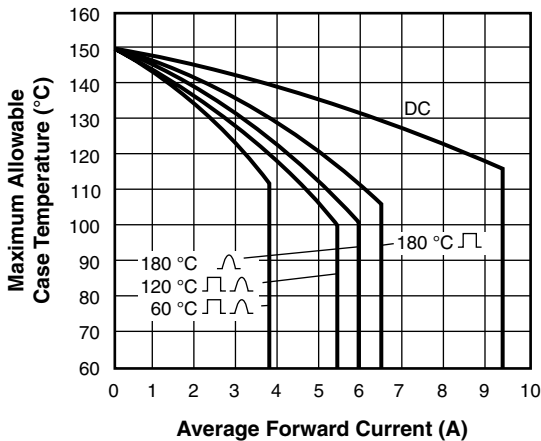

Fig. 1 - Average Forward Current vs. Maximum Allowable Case Temperature, 1N3879 Series

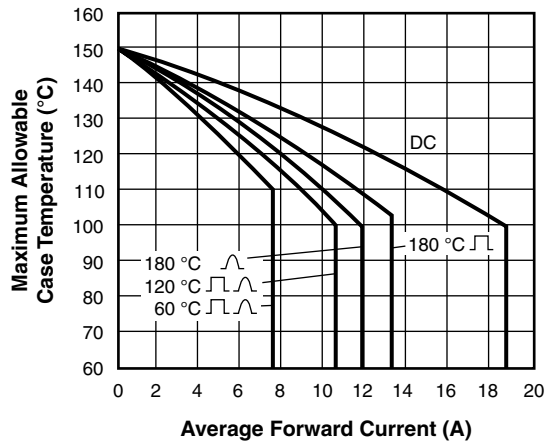
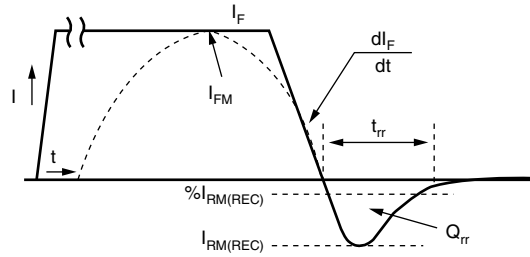

Fig. 2 - Average Forward Current vs. Maximum Allowable Case Temperature, 1N3889 Series



I_F , I_{FM} - Peak forward current prior to commutation
 $-di_F/dt$ - Rate of fall of forward current
 $I_{RM(REC)}$ - Peak reverse recovery current
 t_{rr} - Reverse recovery time
 Q_{rr} - Reverse recovered charge

Fig. 3 - Reverse Recovery Time Test Waveform

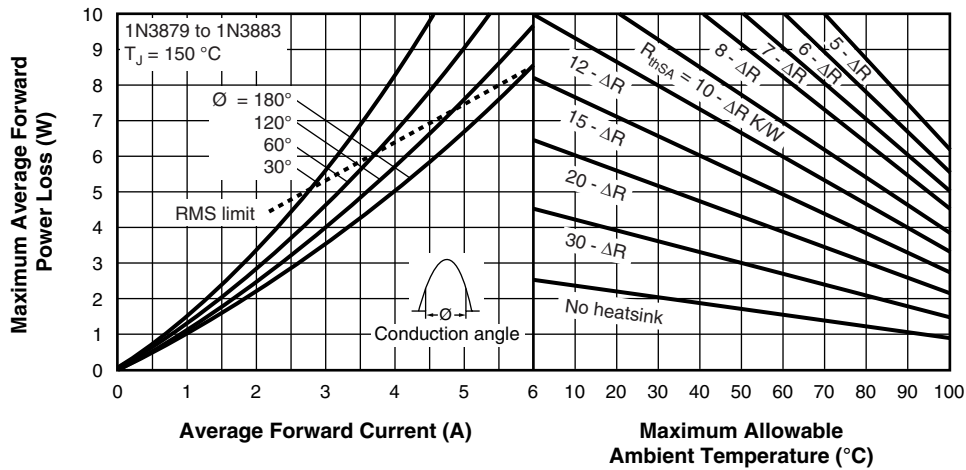

Fig. 4 - Current Rating Nomogram (Sinusoidal Waveforms), 1N3879 Series

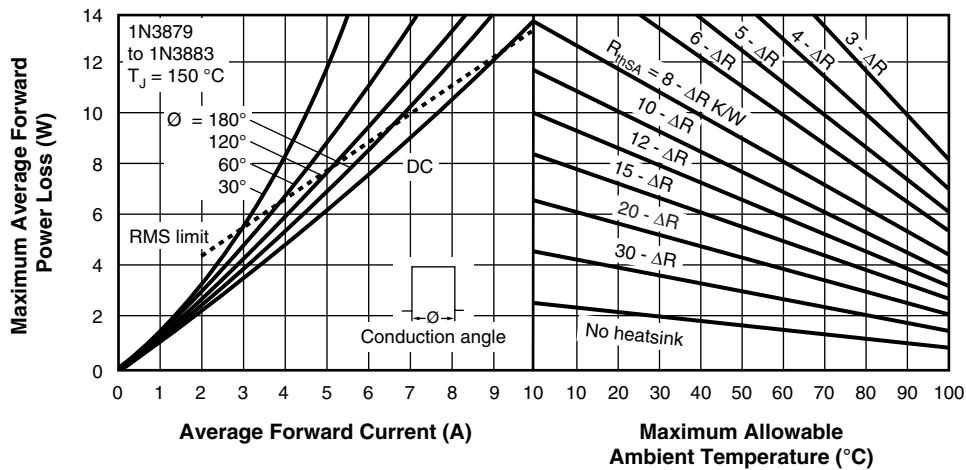
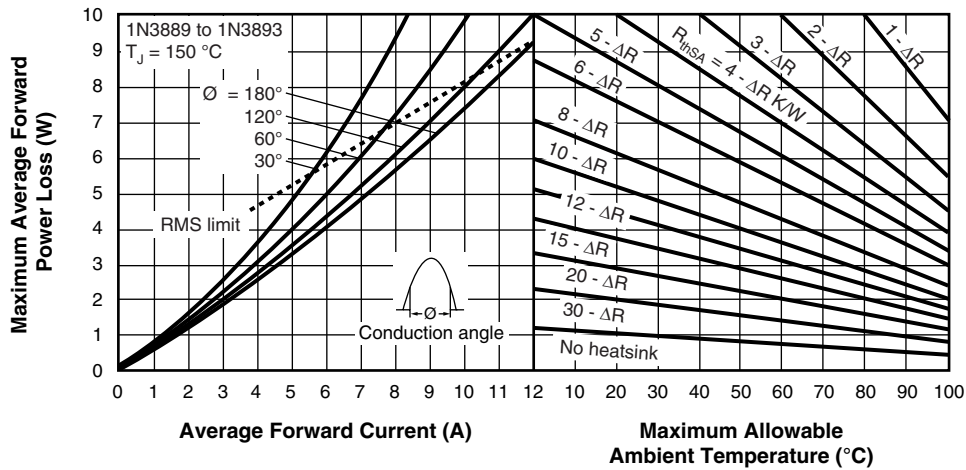
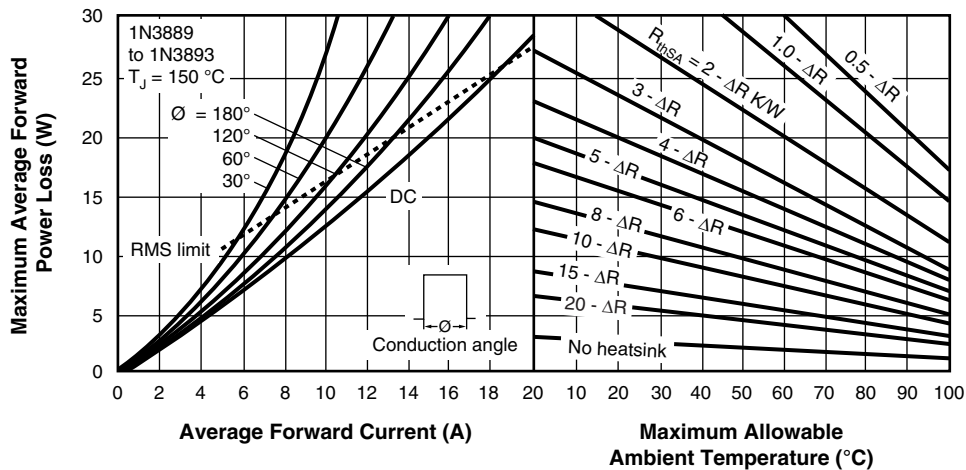

Fig. 5 - Current Rating Nomogram (Rectangular Waveforms), 1N3879 Series



Conduction angle - ϕ	ΔR - KW
180°	0.46
120°	0.48
60°	1.02
30°	1.76

Fig. 6 - Current Rating Nomogram (Sinusoidal Waveforms), 1N3889 Series



Conduction angle - ϕ	ΔR - KW
DC	0
180°	0.26
120°	0.46
60°	1.02
30°	1.76

Fig. 7 - Current Rating Nomogram (Rectangular Waveforms), 1N3889 Series

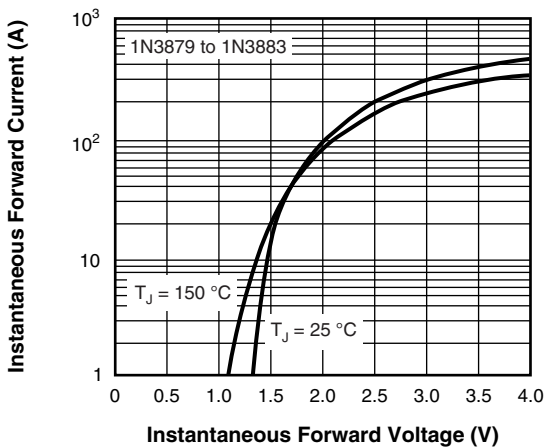

Fig. 8 - Maximum Forward Voltage vs. Forward Current, 1N3879 Series

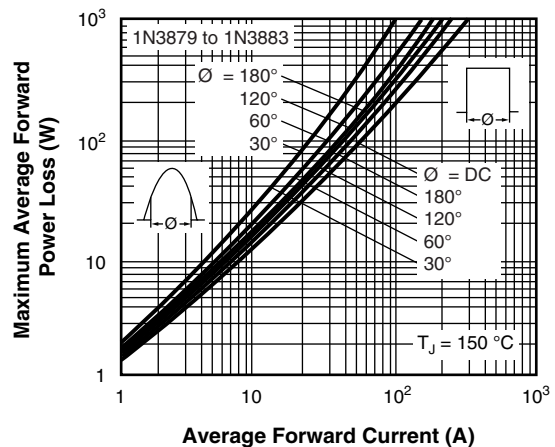

Fig. 9 - Maximum High Level Forward Power Loss vs. Average Forward Current, 1N3879 Series

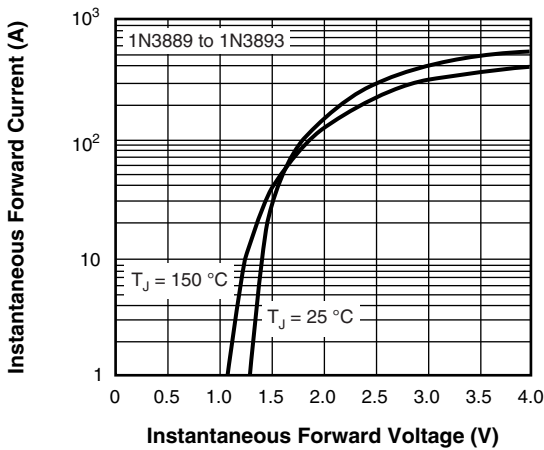

Fig. 10 - Maximum Forward Voltage vs. Forward Current, 1N3889 Series

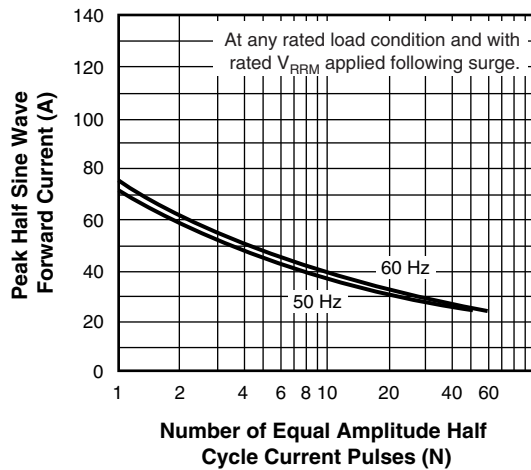

Fig. 12 - Maximum Non-Repetitive Surge Current vs. Number of Current Pulses, 1N3879 Series

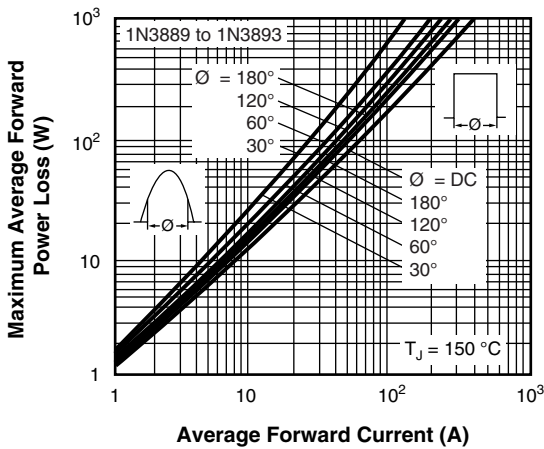

Fig. 11 - Maximum High Level Forward Power Loss vs. Average Forward Current, 1N3889 Series

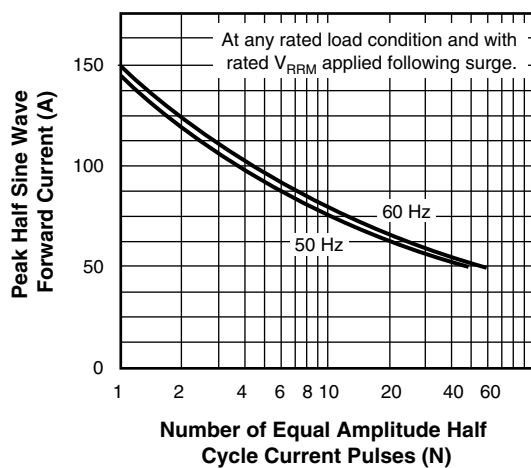

Fig. 13 - Maximum Non-Repetitive Surge Current vs. Number of Current Pulses, 1N3889 Series

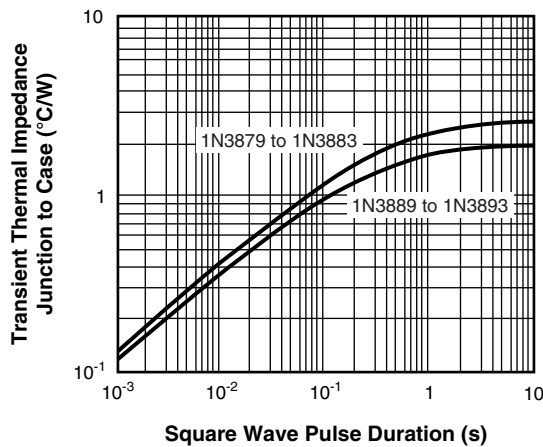

Fig. 14 - Maximum Transient Thermal Impedance, Junction to Case vs. Pulse Duration, All Series

LINKS TO RELATED DOCUMENTS

Dimensions	www.vishay.com/doc?95311
------------	--

DO-203AA (DO-4)

DIMENSIONS in millimeters (inches)

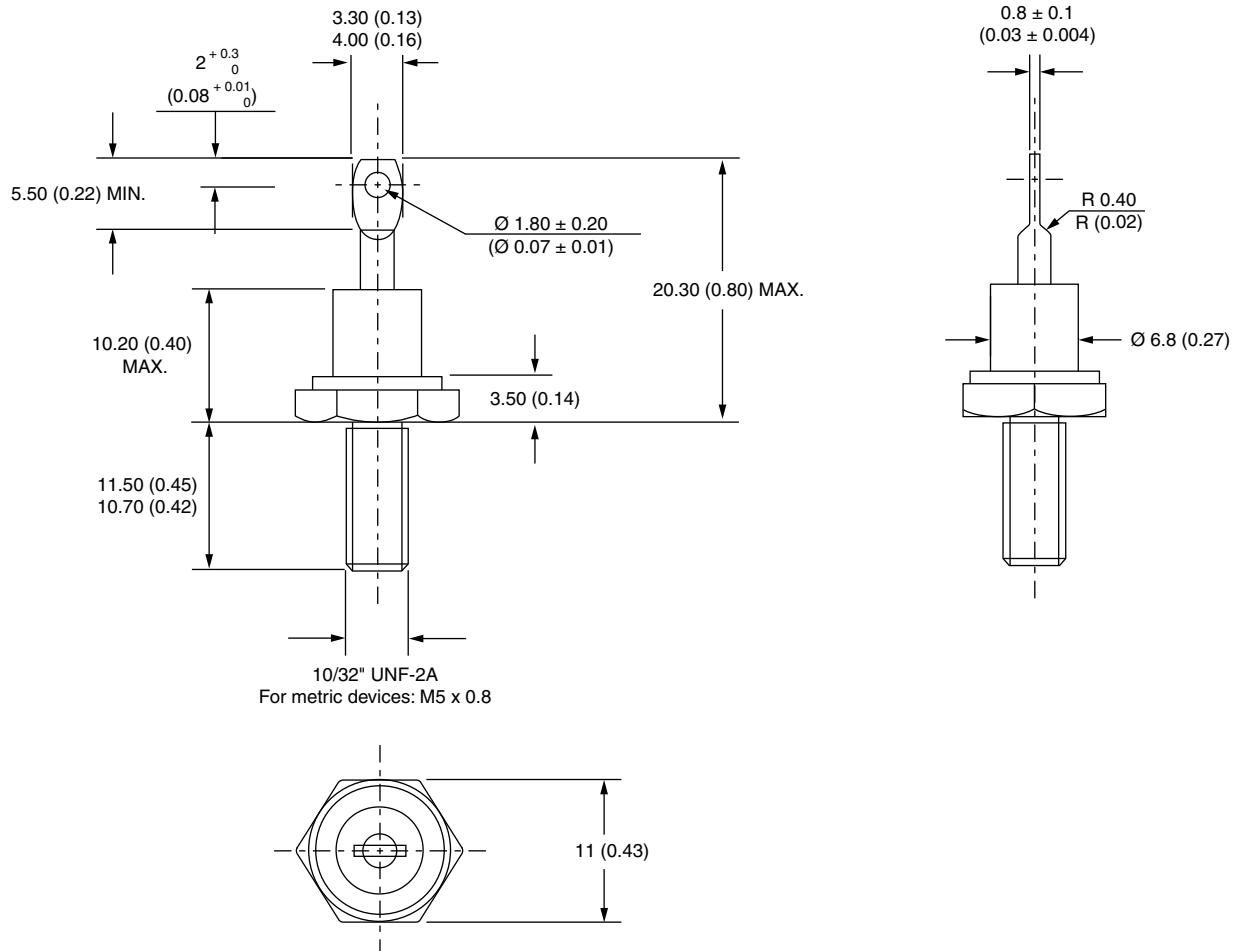



Disclaimer

ALL PRODUCT, PRODUCT SPECIFICATIONS AND DATA ARE SUBJECT TO CHANGE WITHOUT NOTICE TO IMPROVE RELIABILITY, FUNCTION OR DESIGN OR OTHERWISE.

Vishay Intertechnology, Inc., its affiliates, agents, and employees, and all persons acting on its or their behalf (collectively, "Vishay"), disclaim any and all liability for any errors, inaccuracies or incompleteness contained in any datasheet or in any other disclosure relating to any product.

Vishay makes no warranty, representation or guarantee regarding the suitability of the products for any particular purpose or the continuing production of any product. To the maximum extent permitted by applicable law, Vishay disclaims (i) any and all liability arising out of the application or use of any product, (ii) any and all liability, including without limitation special, consequential or incidental damages, and (iii) any and all implied warranties, including warranties of fitness for particular purpose, non-infringement and merchantability.

Statements regarding the suitability of products for certain types of applications are based on Vishay's knowledge of typical requirements that are often placed on Vishay products in generic applications. Such statements are not binding statements about the suitability of products for a particular application. It is the customer's responsibility to validate that a particular product with the properties described in the product specification is suitable for use in a particular application. Parameters provided in datasheets and / or specifications may vary in different applications and performance may vary over time. All operating parameters, including typical parameters, must be validated for each customer application by the customer's technical experts. Product specifications do not expand or otherwise modify Vishay's terms and conditions of purchase, including but not limited to the warranty expressed therein.

Hyperlinks included in this datasheet may direct users to third-party websites. These links are provided as a convenience and for informational purposes only. Inclusion of these hyperlinks does not constitute an endorsement or an approval by Vishay of any of the products, services or opinions of the corporation, organization or individual associated with the third-party website. Vishay disclaims any and all liability and bears no responsibility for the accuracy, legality or content of the third-party website or for that of subsequent links.

Except as expressly indicated in writing, Vishay products are not designed for use in medical, life-saving, or life-sustaining applications or for any other application in which the failure of the Vishay product could result in personal injury or death. Customers using or selling Vishay products not expressly indicated for use in such applications do so at their own risk. Please contact authorized Vishay personnel to obtain written terms and conditions regarding products designed for such applications.

No license, express or implied, by estoppel or otherwise, to any intellectual property rights is granted by this document or by any conduct of Vishay. Product names and markings noted herein may be trademarks of their respective owners.