

EMIPAK 1B PressFit Power Module 600 V Full Bridge MOSFET, 50 A



EMIPAK 1B
(package example)



RoHS
COMPLIANT

FEATURES

- EF series power MOSFET
- Low input capacitance (C_{iss})
- Ultra low gate charge (Q_g)
- Exposed Al_2O_3 substrate with low thermal resistance
- Avalanche energy rated (UIS)
- Low internal inductance
- Qualified using AQG324 guideline as reference
- PressFit pins locking technology
PATENT(S): www.vishay.com/patents
- Material categorization: for definitions of compliance please see www.vishay.com/doc?99912

DESCRIPTION

The EMIPAK 1B package is easy to use thanks to the PressFit pins. The exposed substrate provides improved thermal performance.

The optimized layout also helps to minimize stray parameters, allowing for better EMI performance.

PRIMARY CHARACTERISTICS	
FULL BRIDGE - QB1 to QB4 MOSFET	
V_{DSS}	600 V
$R_{DS(ON)}$ typical at $I_D = 50$ A	37 m Ω
I_D at $T_{CASE} = 77$ °C	50 A
Type	Modules - MOSFET
Package	EMIPAK 1B
Circuit configuration	Full bridge

ABSOLUTE MAXIMUM RATINGS ($T_J = 25$ °C unless otherwise noted)				
PARAMETER	SYMBOL	TEST CONDITIONS	MAX.	UNITS
Operating junction temperature	T_J		150	°C
Storage temperature range	T_{Stg}		-40 to +150	
RMS isolation voltage	V_{ISOL}	$T_J = 25$ °C, all terminals shorted, $f = 50$ Hz, $t = 1$ s	3500	V
QB1 to QB4 - MOSFET				
Drain to source voltage	V_{DSS}		600	V
Gate to source voltage	V_{GS}		± 30	
Pulsed drain current	$I_{DM}^{(1)}$	$V_{GS} = 10$ V	135	A
Continuous drain current	I_D	$T_{SINK} = 25$ °C	44	A
		$T_{SINK} = 80$ °C	34	
Power dissipation	P_D	$T_{SINK} = 25$ °C	173	W
		$T_{SINK} = 80$ °C	97	
Single pulse avalanche energy	E_{AS}	$L = 10$ mH, $I_{AS} = 23$ A, $T_J = 25$ °C	2645	mJ
Pulsed source current (body diode)	I_{SM}		135	A

Note

(1) Pulse width limited by safe operating area

PATENT(S): www.vishay.com/patents

This Vishay product is protected by one or more United States and international patents.



ELECTRICAL SPECIFICATIONS (T _J = 25 °C unless otherwise noted)						
PARAMETER	SYMBOL	TEST CONDITIONS	MIN.	TYP.	MAX.	UNITS
QB1 to QB4 - MOSFET						
Drain to source breakdown voltage	BV _{DSS}	V _{GS} = 0 V, I _D = 250 μA	600	-	-	V
V _{DS} temperature coefficient	ΔV _{DSS} /T _J	Reference to 25 °C, I _D = 1 mA	-	0.46	-	V/°C
Drain to source on resistance	R _{DSON}	V _{GS} = 10 V, I _D = 50 A	-	37	48	mΩ
		V _{GS} = 10 V, I _D = 50 A, T _J = 150 °C	-	82	-	
Gate threshold voltage	V _{GS(th)}	V _{DS} = V _{GS} , I _D = 250 μA	1.8	2.7	4.4	V
Temperature coefficient of threshold voltage	ΔV _{GS(th)} /ΔT _J	V _{DS} = V _{GS} , I _D = 250 μA (25 °C to 125 °C)	-	-11.5	-	mV/°C
Forward transconductance	g _{fs}	V _{DS} = 20 V, I _D = 50 A	-	48	-	S
Transfer characteristics	V _{GS}	V _{DS} = 20 V, I _D = 50 A	-	5.3	-	V
Zero gate voltage drain current	I _{DSS}	V _{GS} = 0 V, V _{DS} = 600 V	-	0.7	10	μA
		V _{GS} = 0 V, V _{DS} = 600 V, T _J = 150 °C	-	1.1	-	mA
Gate to source leakage current	I _{GSS}	V _{GS} = ± 20 V, V _{DS} = 0 V	-	-	± 150	nA
QB1 to QB4 - BODY DIODE						
Source to drain voltage drop	V _{SD}	I _{SD} = 40 A, V _{GS} = 0 V	-	0.92	1.32	V

SWITCHING CHARACTERISTICS (T _J = 25 °C unless otherwise noted)						
PARAMETER	SYMBOL	TEST CONDITIONS	MIN.	TYP.	MAX.	UNITS
QB1 to QB4 - MOSFET						
Total gate charge (turn-on)	Q _g	I _D = 50 A, V _{DS} = 480 V, V _{GS} = 10 V	-	240	-	nC
Gate to source charge (turn-on)	Q _{gs}		-	65	-	
Gate to drain charge (turn-on)	Q _{gd}		-	105	-	
Turn-off energy loss	E _{OFF}	I _D = 50 A, V _{DD} = 450 V, V _{GS} = +10 V / -10 V, R _g = 10 Ω, L = 500 μH	-	0.20	-	mJ
Turn-off delay time	t _{d(off)}		-	141	-	ns
Fall time	t _f		-	17	-	
Turn-off energy loss	E _{OFF}	I _D = 50 A, V _{DD} = 450 V, V _{GS} = +10 V / -10 V, R _g = 10 Ω, L = 500 μH, T _J = 125 °C	-	0.24	-	mJ
Turn-off delay time	t _{d(off)}		-	149	-	ns
Fall time	t _f		-	18	-	
Input capacitance	C _{iss}	V _{GS} = 0 V, V _{DS} = 100 V, f = 1 MHz	-	7500	-	pF
Output capacitance	C _{oss}		-	378	-	
Reverse transfer capacitance	C _{rss}		-	5	-	
Effective output capacitance, energy related	C _{D(er)} ⁽¹⁾	V _{GS} = 0 V, V _{DS} = 0 V to 480 V	-	263	-	pF
Effective output capacitance, time related	C _{D(tr)} ⁽²⁾		-	926	-	
Reverse bias safe operating area	RBSOA	T _J = 150 °C, I _D = 120 A, V _{DD} = 400 V, V _p = 600 V, R _g = 10 Ω, V _{GS} = ± 10 V				
QB1 to QB4 - BODY DIODE						
Diode reverse recovery time	t _{rr}	V _R = 200 V, T _J = 25 °C, I _S = 50 A, dI/dt = 100 A/μs	-	220	-	ns
Diode reverse recovery current	I _{rr}		-	18	-	A
Diode reverse recovery charge	Q _{rr}		-	2000	-	nC

Notes

- (1) C_{oss(er)} is a fixed capacitance that gives the same energy as C_{oss} while V_{DS} is rising from 0 % to 80 % V_{DS}
- (2) C_{oss(tr)} is a fixed capacitance that gives the charging time as C_{oss} while V_{DS} is rising from 0 % to 80 % V_{DS}



INTERNAL NTC - THERMISTOR SPECIFICATIONS				
PARAMETER	SYMBOL	TEST CONDITIONS	VALUE	UNITS
Resistance	R ₂₅	T _C = 25 °C	5000	Ω
	R ₁₀₀	T _C = 100 °C	493 ± 5 %	
B-value	B _{25/50}	$R_2 = R_{25} \exp. [B_{25/50}(1/T_2 - 1/(298.15K))]$	3375 ± 5 %	K
Maximum operating temperature			220	°C
Dissipation constant			2	mW/°C
Thermal time constant			8	s

THERMAL AND MECHANICAL SPECIFICATIONS					
PARAMETER	SYMBOL	MIN.	TYP.	MAX.	UNITS
QB1 to QB4 - MOSFET - Junction to case thermal resistance (per switch)	R _{thJC}	-	-	0.3	°C/W
QB1 to QB4 - MOSFET - Case to sink thermal resistance (per switch)	R _{thCS}	-	0.42	-	°C/W
Case to sink thermal resistance (per module) ⁽¹⁾		-	0.1	-	
Mounting torque (M4)		2	-	3	Nm
Weight		-	28	-	g

Note

⁽¹⁾ Mounting surface flat, smooth, and greased

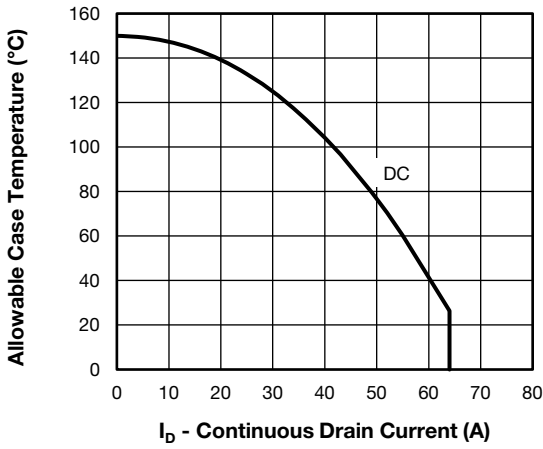

Fig. 1 - Maximum Continuous Drain Current vs. Case Temperature

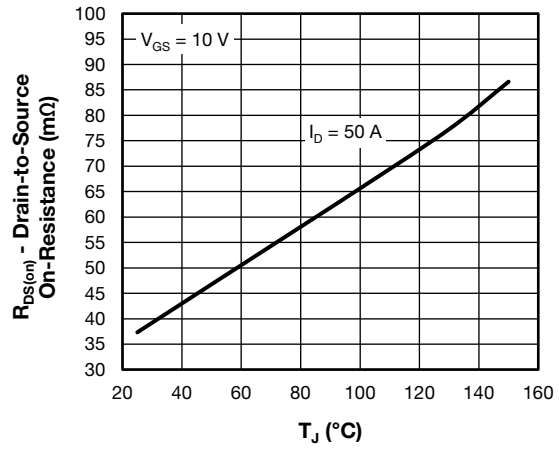

Fig. 4 - Typical Drain to Source On-Resistance vs. Temperature

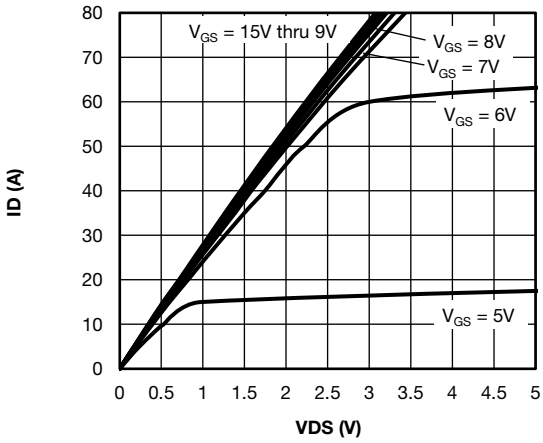

Fig. 2 - Typical Drain to Source Current Output Characteristics at $T_J = 25\text{ }^\circ\text{C}$

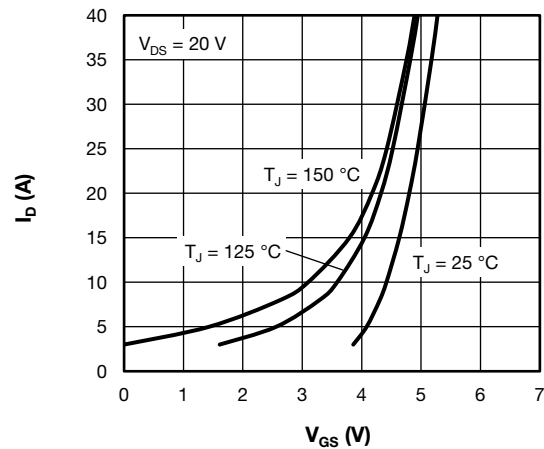

Fig. 5 - Typical Transfer Characteristics

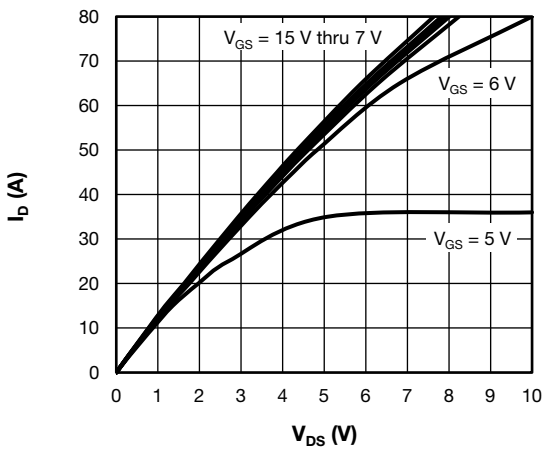

Fig. 3 - Typical Drain to Source Current Output Characteristics at $T_J = 150\text{ }^\circ\text{C}$

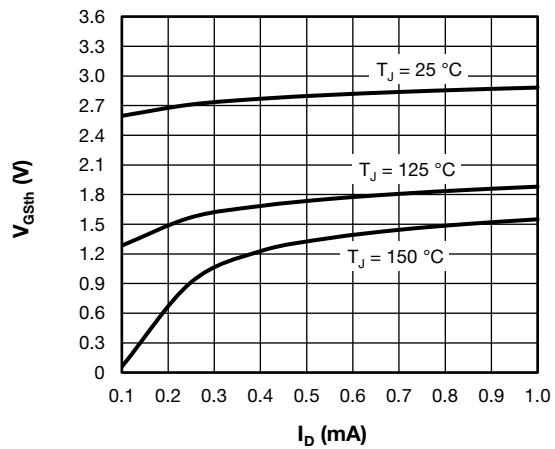

Fig. 6 - Typical Gate Threshold Voltage Characteristics

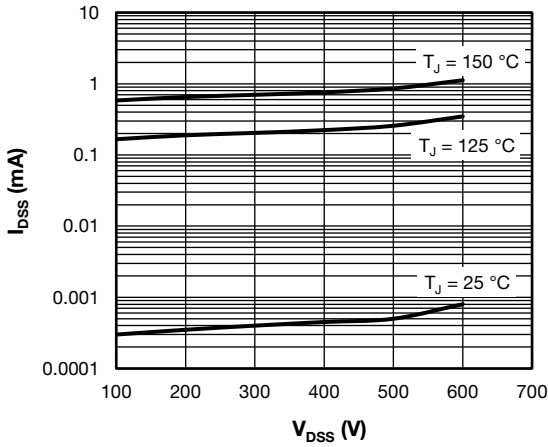

Fig. 7 - Typical Zero Gate Voltage Drain Current

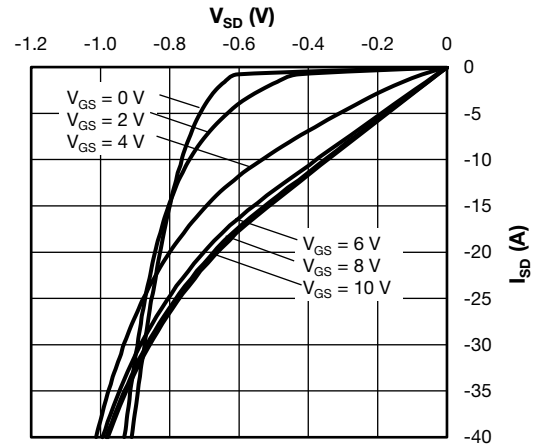

Fig. 10 - Typical Source to Drain Current Characteristics at $T_J = 25^\circ\text{C}$

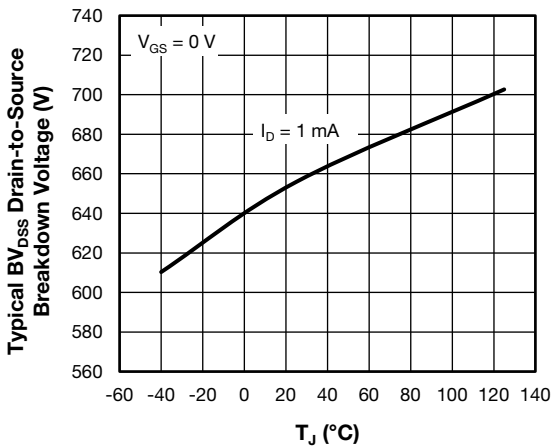

Fig. 8 - Typical Drain to Source Breakdown Voltage vs. Temperature

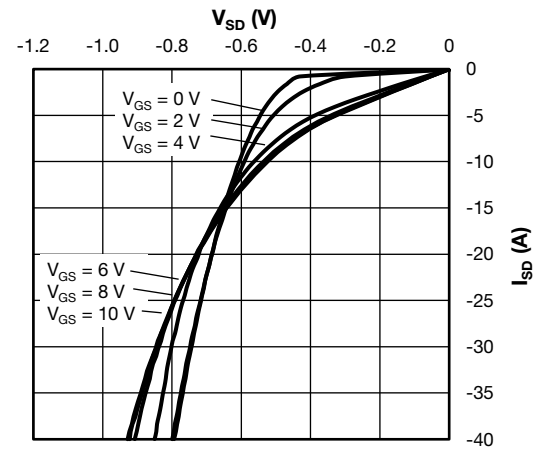

Fig. 11 - Typical Source to Drain Current Characteristics at $T_J = 125^\circ\text{C}$

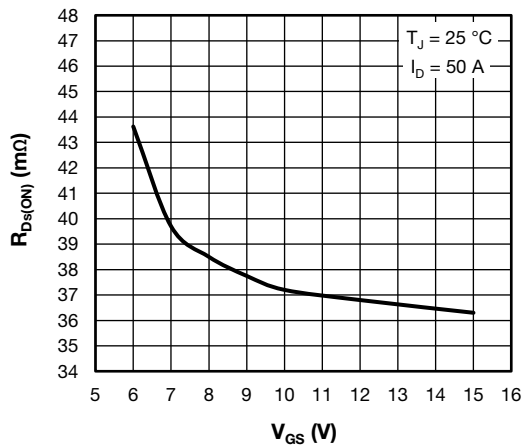

Fig. 9 - Typical Drain-State Resistance vs. Gate to Source Voltage

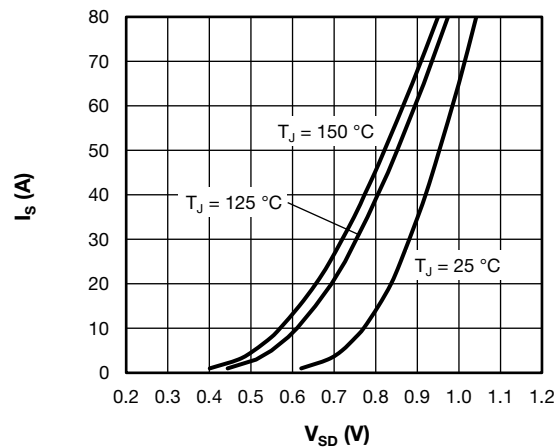

Fig. 12 - Typical Body Diode Source to Drain Current Characteristics

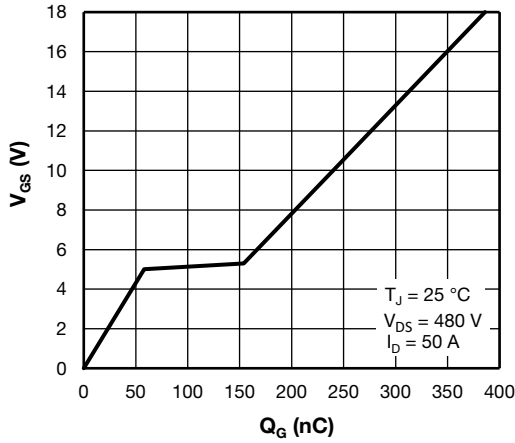

Fig. 13 - Typical Gate Charge vs. Gate to Source Voltage

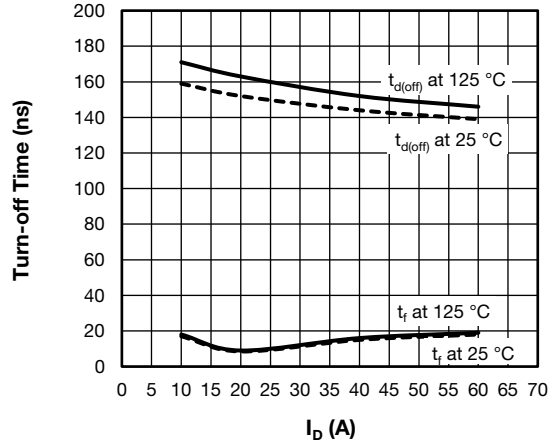

Fig. 16 - Typical Turn-off Switching Time vs. I_D
 $V_{DD} = 450\text{ V}$, $R_g = 10\ \Omega$, $V_{GS} = \pm 10\text{ V}$, $L = 500\ \mu\text{H}$

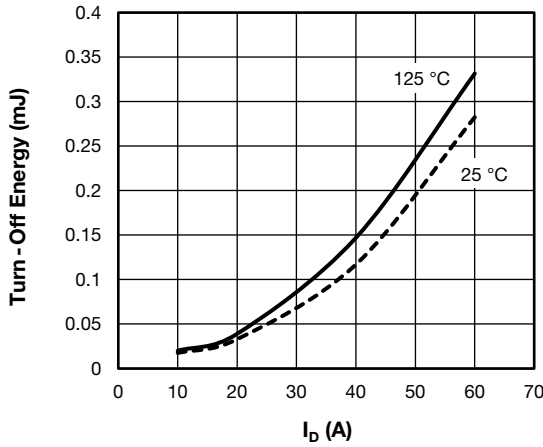

Fig. 14 - Typical Turn-off Energy Loss vs. I_D
 $V_{DD} = 450\text{ V}$, $R_g = 10\ \Omega$, $V_{GS} = \pm 10\text{ V}$, $L = 500\ \mu\text{H}$

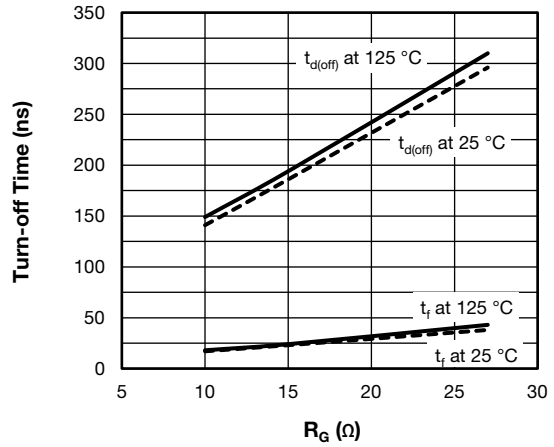

Fig. 17 - Typical Turn-off Switching Time vs. R_g
 $V_{DD} = 450\text{ V}$, $I_D = 50\text{ A}$, $V_{GS} = \pm 10\text{ V}$, $L = 500\ \mu\text{H}$

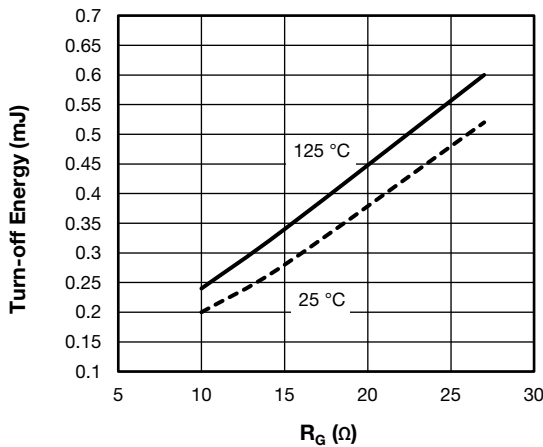

Fig. 15 - Typical Turn-off Energy Loss vs. R_g
 $V_{DD} = 450\text{ V}$, $I_D = 50\text{ A}$, $V_{GS} = \pm 10\text{ V}$, $L = 500\ \mu\text{H}$

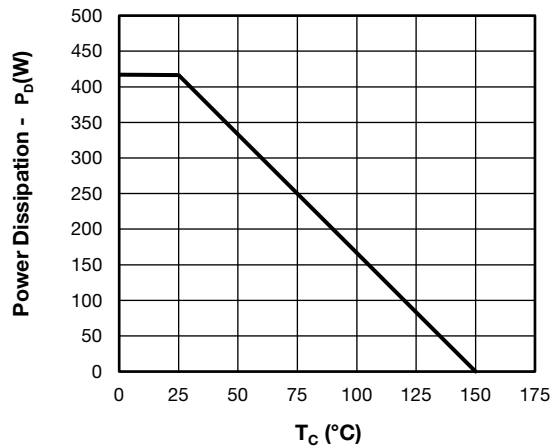

Fig. 18 - Power Dissipation Curve

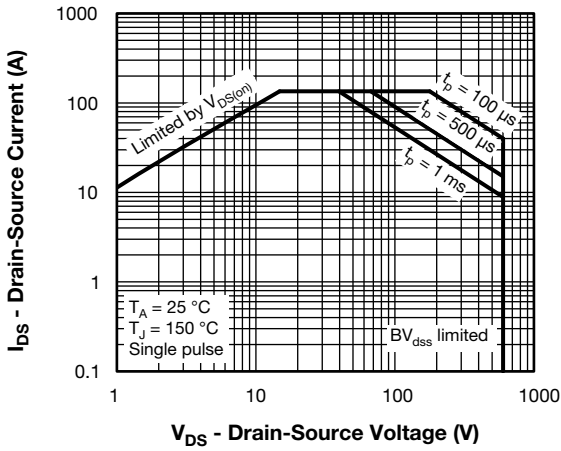

Fig. 19 - Safe Operating Area

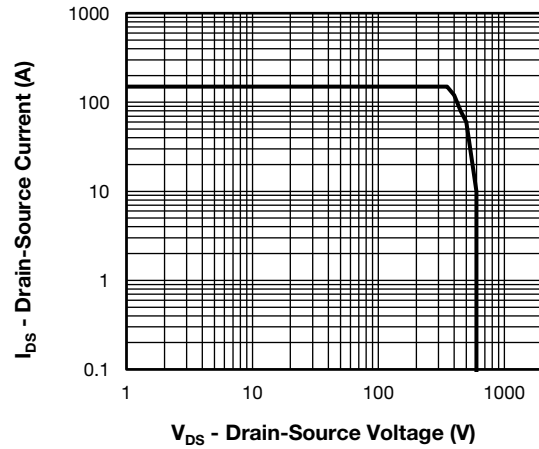

Fig. 20 - Reverse BIAS SOA

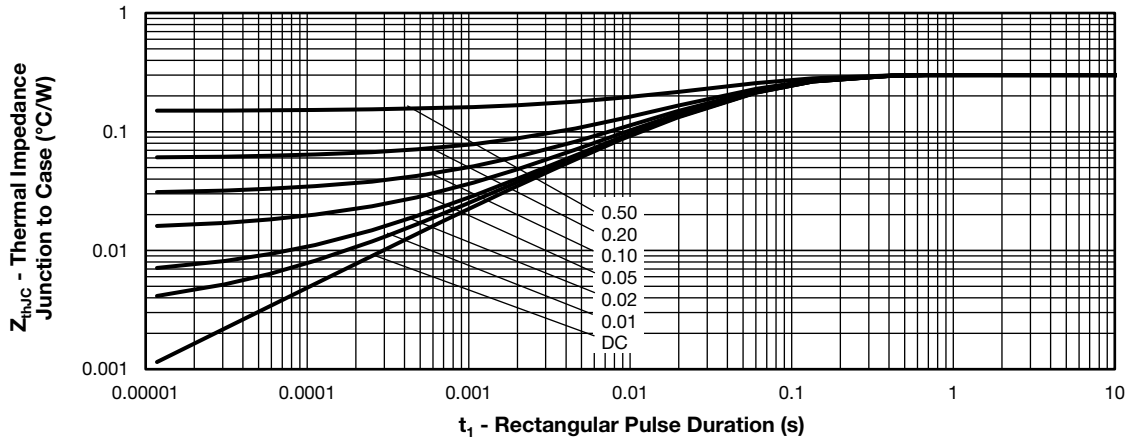
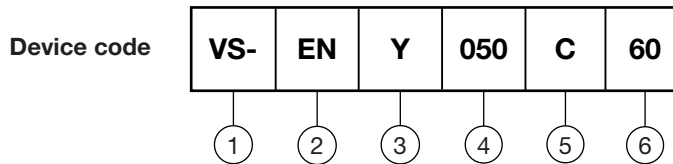

Fig. 21 - Maximum Thermal Impedance Z_{thJC} Characteristics

ORDERING INFORMATION



- 1** - Vishay Semiconductors product
- 2** - Package indicator (EN = EMIPAK 1B)
- 3** - Circuit configuration (Y = full bridge topology)
- 4** - Current rating (050 = 50 A)
- 5** - Switch die technology (C = PowerMOS)
- 6** - Voltage rating (60 = 600 V)

CIRCUIT CONFIGURATION

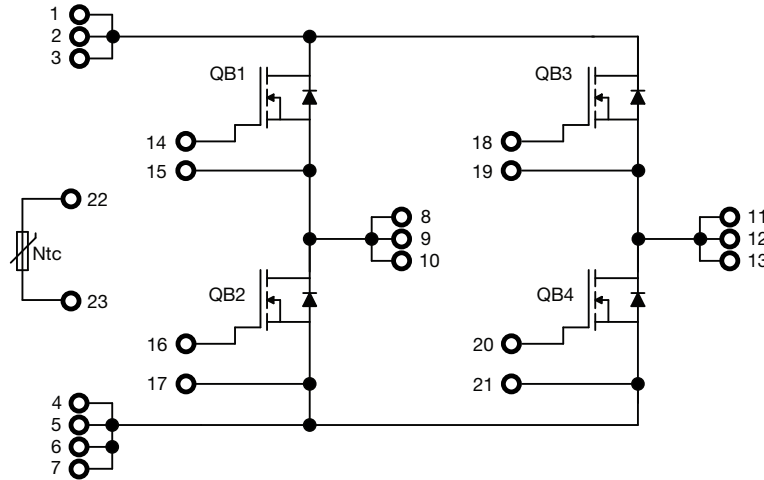

PACKAGE

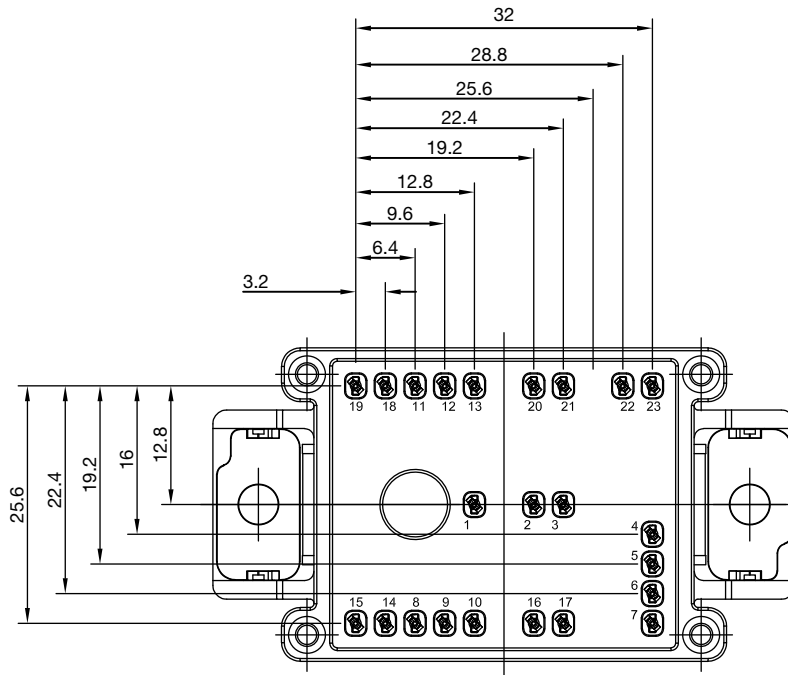

LINKS TO RELATED DOCUMENTS	
Dimensions	www.vishay.com/doc?95558
Application Note	www.vishay.com/doc?95580



Disclaimer

ALL PRODUCT, PRODUCT SPECIFICATIONS AND DATA ARE SUBJECT TO CHANGE WITHOUT NOTICE TO IMPROVE RELIABILITY, FUNCTION OR DESIGN OR OTHERWISE.

Vishay Intertechnology, Inc., its affiliates, agents, and employees, and all persons acting on its or their behalf (collectively, "Vishay"), disclaim any and all liability for any errors, inaccuracies or incompleteness contained in any datasheet or in any other disclosure relating to any product.

Vishay makes no warranty, representation or guarantee regarding the suitability of the products for any particular purpose or the continuing production of any product. To the maximum extent permitted by applicable law, Vishay disclaims (i) any and all liability arising out of the application or use of any product, (ii) any and all liability, including without limitation special, consequential or incidental damages, and (iii) any and all implied warranties, including warranties of fitness for particular purpose, non-infringement and merchantability.

Statements regarding the suitability of products for certain types of applications are based on Vishay's knowledge of typical requirements that are often placed on Vishay products in generic applications. Such statements are not binding statements about the suitability of products for a particular application. It is the customer's responsibility to validate that a particular product with the properties described in the product specification is suitable for use in a particular application. Parameters provided in datasheets and / or specifications may vary in different applications and performance may vary over time. All operating parameters, including typical parameters, must be validated for each customer application by the customer's technical experts. Product specifications do not expand or otherwise modify Vishay's terms and conditions of purchase, including but not limited to the warranty expressed therein.

Hyperlinks included in this datasheet may direct users to third-party websites. These links are provided as a convenience and for informational purposes only. Inclusion of these hyperlinks does not constitute an endorsement or an approval by Vishay of any of the products, services or opinions of the corporation, organization or individual associated with the third-party website. Vishay disclaims any and all liability and bears no responsibility for the accuracy, legality or content of the third-party website or for that of subsequent links.

Except as expressly indicated in writing, Vishay products are not designed for use in medical, life-saving, or life-sustaining applications or for any other application in which the failure of the Vishay product could result in personal injury or death. Customers using or selling Vishay products not expressly indicated for use in such applications do so at their own risk. Please contact authorized Vishay personnel to obtain written terms and conditions regarding products designed for such applications.

No license, express or implied, by estoppel or otherwise, to any intellectual property rights is granted by this document or by any conduct of Vishay. Product names and markings noted herein may be trademarks of their respective owners.