

VDR Metal Oxide Varistors High Surge

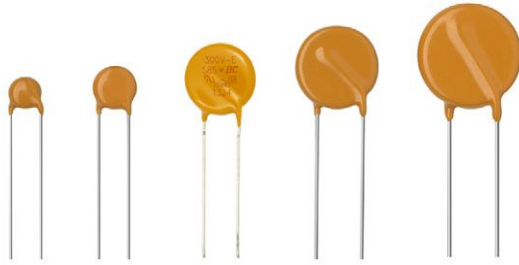

LINKS TO ADDITIONAL RESOURCES



| QUICK REFERENCE DATA | | |
|---|---|------|
| PARAMETER | VALUE | UNIT |
| Maximum continuous voltage in operating temperature range: | | |
| RMS | 11 to 680 | V |
| DC | 14 to 895 | V |
| Maximum non-repetitive transient current I_{NRP} (8 x 20 μ s) | 250 to 10 000 | A |
| Maximum energy (10/1000 μ s) | 0.7 to 620 | J |
| Detailed specification | Based on IEC 61051-1 IEC 61051-2 IEC 61051-2-2 | |
| Storage temperature | -40 to +150 | °C |
| Operating temperature | -40 to +125 | °C |

ORDERING INFORMATION

The varistors are available in a number of packaging options:

- Bulk
- On tape on reel
- On tape in ammpack (fanfold)

The basic ordering code for each option is given in tables titled Varistors on Tape on Reel, Varistors on Tape in Ammpack, and Varistors in Bulk. To complete the catalog number and to determine the required operating parameters, see Electrical Data and Ordering Information table.

Note

- Special lead-configuration as inside or outside crimped leads on request

AGENCY APPROVALS

- cUL certificate
- ULus certificate
- VDE/IEC certificate

Note

- Agency approval documents, please see: www.vishay.com/ppg?29082&documents

FEATURES

- Low β high purity zinc oxide disc
- Halogen free insulating epoxy coating
- Straight or kinked leads
- Higher current surge/size ratio capability up to 10 kA for H20 types
- Certified for operation up to 85 °C according to UL 1449 edition 4, VDE/IEC 61051-1/2
- Material categorization: for definitions of compliance please see www.vishay.com/doc?99912



RoHS
COMPLIANT
HALOGEN
FREE

APPLICATION

- Overvoltage and transient voltage protection

DESCRIPTION

The varistors consist of a disc of low- β ceramic material with two solid copper leads (H20 types only) or copper clad steel wire. The wires have a matte tin plating. They are coated with UL 94 V-0 approved ochre colored halogen-free epoxy, which provides electrical, mechanical and climatic protection. The encapsulation is resistant to all cleaning solvents in accordance with IEC 60068-2-45.

MOUNTING

The varistors are suitable for hand-mounting (bulk) or automatic pick and place mounting (tape on reel or fanfold). The parts can be soldered by hand or wave soldering. Pin-in-paste reflow soldering is not recommended. Bending of the leads for different angle placement is not recommended.

Typical Soldering

235 °C, duration: 5 s (Pb-bearing)
245 °C, duration: 5 s (lead (Pb)-free)

Resistance to Soldering Heat

260 °C, duration: 10 s max.

MARKING

The varistors are marked with the following information:

- Maximum continuous RMS voltage with - E suffix
- Series numbers
 - 582 for VDRH05
 - 583 for VDRH07
 - 584 for VDRH10
 - 585 for VDRH14
 - 586 for VDRH20
- Manufacture logo
- Date of manufacture (YYWW)
- Safety marks on VDRH10-14-20 types

INFLAMMABILITY

The varistors are passive non-flammable. The encapsulation is made of flame resistant epoxy in accordance with UL 94 V-0.



| ELECTRICAL DATA AND ORDERING INFORMATION | | | | | | | | | | | |
|--|--------|--------------------------------|-----------------------------------|-------|--|--|---|------------------------------|----------|-----------|---|
| MAXIMUM CONTINUOUS VOLTAGE | | VOLTAGE ⁽³⁾ AT 1 mA | MAXIMUM VOLTAGE AT STATED CURRENT | | MAXIMUM ENERGY ⁽⁴⁾ (10 x 1000 µs) | MAXIMUM NON-REP. TRANSIENT CURRENT ⁽⁵⁾ I _{NRP} (8 x 20 µs) | NOMINAL DISCHARGE CURRENT ⁽⁷⁾ I _N | TYPICAL CAPACITANCE AT 1 kHz | T (max.) | E | SAP MATERIAL AND ORDERING NUMBER ⁽¹⁾ xy ⁽⁶⁾ |
| RMS ⁽²⁾ (V) | DC (V) | (V) | V (V) | I (A) | (J) | (A) | (kA) | (pF) | (mm) | (mm) | |
| 11 | 14 | 18 | 40 | 1.0 | 0.7 | 250 | 0.10 | 1600 | 3.4 | 0.5 ± 0.3 | VDRH05B011xyE |
| | | | 36 | 2.5 | 1.5 | 500 | 0.15 | 3600 | 3.4 | 0.5 ± 0.3 | VDRH07D011xyE |
| | | | 36 | 5.0 | 2.6 | 1000 | 0.50 | 8000 | 3.8 | 0.7 ± 0.3 | VDRH10G011xyE |
| | | | 36 | 10.0 | 5.2 | 2000 | 1.00 | 20 000 | 3.8 | 0.7 ± 0.3 | VDRH14M011xyE |
| 14 | 18 | 22 | 48 | 1.0 | 0.8 | 250 | 0.10 | 1300 | 3.4 | 0.7 ± 0.3 | VDRH05B014xyE |
| | | | 43 | 2.5 | 1.7 | 500 | 0.15 | 2800 | 3.4 | 0.7 ± 0.3 | VDRH07D014xyE |
| | | | 43 | 5.0 | 3.2 | 1000 | 0.50 | 6000 | 3.8 | 0.9 ± 0.3 | VDRH10G014xyE |
| | | | 43 | 10.0 | 6.3 | 2000 | 1.00 | 15 000 | 3.8 | 0.9 ± 0.3 | VDRH14M014xyE |
| | | | 43 | 20.0 | 16.0 | 3000 | 2.00 | 30 000 | 4.2 | 1.1 ± 0.3 | VDRH20R014ByE |
| 17 | 22 | 27 | 60 | 1.0 | 1.1 | 250 | 0.10 | 1050 | 3.7 | 0.8 ± 0.3 | VDRH05B017xyE |
| | | | 53 | 2.5 | 2.1 | 500 | 0.15 | 2000 | 3.7 | 0.8 ± 0.3 | VDRH07D017xyE |
| | | | 53 | 5.0 | 3.9 | 1000 | 0.50 | 4000 | 4.1 | 1.0 ± 0.3 | VDRH10G017xyE |
| | | | 53 | 10.0 | 7.8 | 2000 | 1.00 | 10 000 | 4.1 | 1.0 ± 0.3 | VDRH14M017xyE |
| | | | 53 | 20.0 | 19.0 | 3000 | 2.00 | 20 000 | 4.5 | 1.2 ± 0.3 | VDRH20R017ByE |
| 20 | 26 | 33 | 73 | 1.0 | 1.3 | 250 | 0.10 | 900 | 3.9 | 1.0 ± 0.3 | VDRH05B020xyE |
| | | | 65 | 2.5 | 2.8 | 500 | 0.15 | 1500 | 3.9 | 1.0 ± 0.3 | VDRH07D020xyE |
| | | | 65 | 5.0 | 4.8 | 1000 | 0.50 | 3000 | 4.3 | 1.2 ± 0.3 | VDRH10G020xyE |
| | | | 65 | 10.0 | 9.5 | 2000 | 1.00 | 7500 | 4.3 | 1.2 ± 0.3 | VDRH14M020xyE |
| | | | 65 | 20.0 | 24.0 | 3000 | 2.00 | 15 000 | 4.7 | 1.4 ± 0.3 | VDRH20R020ByE |
| 25 | 31 | 39 | 86 | 1.0 | 1.5 | 250 | 0.10 | 500 | 4.2 | 1.2 ± 0.3 | VDRH05B025xyE |
| | | | 77 | 2.5 | 3.0 | 500 | 0.15 | 1350 | 4.2 | 1.2 ± 0.3 | VDRH07D025xyE |
| | | | 77 | 5.0 | 5.6 | 1000 | 0.50 | 2600 | 4.6 | 1.4 ± 0.3 | VDRH10G025xyE |
| | | | 77 | 10.0 | 11.0 | 2000 | 1.00 | 6500 | 4.6 | 1.4 ± 0.3 | VDRH14M025xyE |
| | | | 77 | 20.0 | 28.0 | 3000 | 2.00 | 13 000 | 5.0 | 1.6 ± 0.3 | VDRH20R025ByE |
| 30 | 38 | 47 | 104 | 1.0 | 1.8 | 250 | 0.10 | 700 | 4.4 | 1.4 ± 0.5 | VDRH05B030xyE |
| | | | 93 | 2.5 | 3.8 | 500 | 0.15 | 1600 | 4.4 | 1.4 ± 0.5 | VDRH07D030xyE |
| | | | 93 | 5.0 | 6.8 | 1000 | 0.50 | 2700 | 4.8 | 1.6 ± 0.5 | VDRH10G030xyE |
| | | | 93 | 10.0 | 14.0 | 2000 | 1.00 | 6000 | 4.8 | 1.6 ± 0.5 | VDRH14M030xyE |
| | | | 93 | 20.0 | 34.0 | 3000 | 2.00 | 12 000 | 5.2 | 1.8 ± 0.5 | VDRH20R030ByE |
| 35 | 45 | 56 | 123 | 1.0 | 2.2 | 250 | 0.10 | 560 | 4.8 | 1.7 ± 0.5 | VDRH05B035xyE |
| | | | 110 | 2.5 | 4.4 | 500 | 0.15 | 1300 | 4.8 | 1.7 ± 0.5 | VDRH07D035xyE |
| | | | 110 | 5.0 | 8.1 | 1000 | 0.50 | 2200 | 5.2 | 1.9 ± 0.5 | VDRH10G035xyE |
| | | | 110 | 10.0 | 16.0 | 2000 | 1.00 | 4800 | 5.2 | 1.9 ± 0.5 | VDRH14M035xyE |
| | | | 110 | 20.0 | 41.0 | 3000 | 2.00 | 9600 | 5.6 | 2.1 ± 0.5 | VDRH20R035ByE |
| 40 | 56 | 68 | 150 | 1.0 | 2.6 | 250 | 0.10 | 460 | 5.1 | 2.1 ± 0.5 | VDRH05B040xyE |
| | | | 135 | 2.5 | 5.4 | 500 | 0.15 | 1000 | 5.1 | 2.1 ± 0.5 | VDRH07D040xyE |
| | | | 135 | 5.0 | 9.8 | 1000 | 0.50 | 1800 | 5.5 | 2.3 ± 0.5 | VDRH10G040xyE |
| | | | 135 | 10.0 | 20.0 | 2000 | 1.00 | 3800 | 5.5 | 2.3 ± 0.5 | VDRH14M040xyE |
| | | | 135 | 20.0 | 49.0 | 3000 | 2.00 | 7600 | 5.9 | 2.5 ± 0.5 | VDRH20R040ByE |
| 50 | 65 | 82 | 145 | 5.0 | 3.5 | 800 | 0.10 | 370 | 3.5 | 0.6 ± 0.3 | VDRH05E050xyE |
| | | | 135 | 10.0 | 7.0 | 1750 | 1.00 | 900 | 3.5 | 0.6 ± 0.3 | VDRH07K050xyE |
| | | | 135 | 25.0 | 14.0 | 3500 | 1.50 | 1500 | 3.9 | 0.8 ± 0.3 | VDRH10S050xyE |
| | | | 135 | 50.0 | 28.0 | 6000 | 3.00 | 3100 | 3.9 | 0.8 ± 0.3 | VDRH14V050xyE |



| ELECTRICAL DATA AND ORDERING INFORMATION | | | | | | | | | | | |
|--|--------|--------------------------------|-----------------------------------|-------|--|--|---|------------------------------|----------|-----------|---|
| MAXIMUM CONTINUOUS VOLTAGE | | VOLTAGE ⁽³⁾ AT 1 mA | MAXIMUM VOLTAGE AT STATED CURRENT | | MAXIMUM ENERGY ⁽⁴⁾ (10 x 1000 μs) | MAXIMUM NON-REP. TRANSIENT CURRENT ⁽⁵⁾ I _{NRP} (8 x 20 μs) | NOMINAL DISCHARGE CURRENT ⁽⁷⁾ I _N | TYPICAL CAPACITANCE AT 1 kHz | T (max.) | E | SAP MATERIAL AND ORDERING NUMBER ⁽¹⁾ xy ⁽⁶⁾ |
| RMS ⁽²⁾ (V) | DC (V) | (V) | V (V) | I (A) | (J) | (A) | (kA) | (pF) | (mm) | (mm) | |
| 60 | 85 | 100 | 175 | 5.0 | 4.5 | 800 | 0.10 | 290 | 3.7 | 0.7 ± 0.3 | VDRH05E060xyE |
| | | | 165 | 10.0 | 9.0 | 1750 | 1.00 | 700 | 3.7 | 0.7 ± 0.3 | VDRH07K060xyE |
| | | | 165 | 25.0 | 18.0 | 3500 | 1.50 | 1200 | 4.1 | 0.9 ± 0.3 | VDRH10S060xyE |
| | | | 165 | 50.0 | 36.0 | 6000 | 3.00 | 2300 | 4.1 | 0.9 ± 0.3 | VDRH14V060xyE |
| | | | 165 | 100.0 | 72.0 | 10 000 | 5.00 | 4600 | 4.5 | 1.1 ± 0.3 | VDRH20X060ByE |
| 75 | 100 | 120 | 210 | 5.0 | 5.5 | 800 | 0.10 | 240 | 4.0 | 0.9 ± 0.3 | VDRH05E075xyE |
| | | | 200 | 10.0 | 11.0 | 1750 | 1.00 | 530 | 4.0 | 0.9 ± 0.3 | VDRH07K075xyE |
| | | | 200 | 25.0 | 22.0 | 3500 | 1.50 | 1000 | 4.4 | 1.1 ± 0.3 | VDRH10S075xyE |
| | | | 200 | 50.0 | 44.0 | 6000 | 3.00 | 1900 | 4.4 | 1.1 ± 0.3 | VDRH14V075xyE |
| | | | 200 | 100.0 | 88.0 | 10 000 | 5.00 | 3800 | 4.8 | 1.3 ± 0.3 | VDRH20X075ByE |
| 95 | 125 | 150 | 260 | 5.0 | 6.5 | 800 | 0.10 | 180 | 4.2 | 1.1 ± 0.3 | VDRH05E095xyE |
| | | | 250 | 10.0 | 13.0 | 1750 | 1.00 | 450 | 4.2 | 1.1 ± 0.3 | VDRH07K095xyE |
| | | | 250 | 25.0 | 25.0 | 3500 | 1.50 | 800 | 4.6 | 1.3 ± 0.3 | VDRH10S095xyE |
| | | | 250 | 50.0 | 53.0 | 6000 | 3.00 | 1500 | 4.6 | 1.3 ± 0.3 | VDRH14V095xyE |
| | | | 250 | 100.0 | 106.0 | 10 000 | 5.00 | 3000 | 5.0 | 1.5 ± 0.3 | VDRH20X095ByE |
| 115 | 150 | 180 | 320 | 5.0 | 8.0 | 800 | 0.10 | 150 | 3.6 | 0.9 ± 0.3 | VDRH05E115xyE |
| | | | 300 | 10.0 | 16.0 | 1750 | 1.00 | 390 | 3.6 | 0.9 ± 0.3 | VDRH07K115xyE |
| | | | 300 | 25.0 | 32.0 | 3500 | 1.50 | 680 | 4.0 | 1.1 ± 0.3 | VDRH10S115xyE |
| | | | 300 | 50.0 | 65.0 | 6000 | 3.00 | 1320 | 4.0 | 1.1 ± 0.3 | VDRH14V115xyE |
| | | | 300 | 100.0 | 130.0 | 10 000 | 5.00 | 2640 | 4.4 | 1.3 ± 0.3 | VDRH20X115ByE |
| 130 | 170 | 205 | 355 | 5.0 | 8.5 | 800 | 0.10 | 130 | 3.8 | 1.0 ± 0.3 | VDRH05E130xyE |
| | | | 340 | 10.0 | 17.5 | 1750 | 1.00 | 320 | 3.8 | 1.0 ± 0.3 | VDRH07K130xyE |
| | | | 340 | 25.0 | 35.0 | 3500 | 1.50 | 580 | 4.3 | 1.2 ± 0.3 | VDRH10S130xyE |
| | | | 340 | 50.0 | 70.0 | 6000 | 3.00 | 1050 | 4.3 | 1.2 ± 0.3 | VDRH14V130xyE |
| | | | 340 | 100.0 | 140.0 | 10 000 | 5.00 | 2100 | 4.8 | 1.4 ± 0.3 | VDRH20X130ByE |
| 140 | 180 | 220 | 380 | 5.0 | 9.0 | 800 | 0.10 | 120 | 3.9 | 1.0 ± 0.3 | VDRH05E140xyE |
| | | | 360 | 10.0 | 19.0 | 1750 | 1.00 | 290 | 3.9 | 1.0 ± 0.3 | VDRH07K140xyE |
| | | | 360 | 25.0 | 39.0 | 3500 | 1.50 | 540 | 4.3 | 1.2 ± 0.3 | VDRH10S140xyE |
| | | | 360 | 50.0 | 78.0 | 6000 | 3.00 | 950 | 4.3 | 1.2 ± 0.3 | VDRH14V140xyE |
| | | | 360 | 100.0 | 155.0 | 10 000 | 5.00 | 1900 | 4.8 | 1.5 ± 0.3 | VDRH20X140ByE |
| 150 | 200 | 240 | 415 | 5.0 | 10.5 | 800 | 0.10 | 110 | 4.1 | 1.1 ± 0.3 | VDRH05E150xyE |
| | | | 395 | 10.0 | 21.0 | 1750 | 1.00 | 270 | 4.1 | 1.1 ± 0.3 | VDRH07K150xyE |
| | | | 395 | 25.0 | 42.0 | 3500 | 1.50 | 490 | 4.3 | 1.3 ± 0.3 | VDRH10S150xyE |
| | | | 395 | 50.0 | 84.0 | 6000 | 3.00 | 850 | 4.3 | 1.3 ± 0.3 | VDRH14V150xyE |
| | | | 395 | 100.0 | 168.0 | 10 000 | 5.00 | 1700 | 4.8 | 1.5 ± 0.3 | VDRH20X150ByE |
| 175 | 225 | 275 | 475 | 5.0 | 11.0 | 800 | 0.10 | 90 | 4.1 | 1.3 ± 0.3 | VDRH05E175xyE |
| | | | 455 | 10.0 | 24.0 | 1750 | 1.00 | 230 | 4.1 | 1.3 ± 0.3 | VDRH07K175xyE |
| | | | 455 | 25.0 | 49.0 | 3500 | 1.50 | 430 | 4.5 | 1.5 ± 0.3 | VDRH10S175xyE |
| | | | 455 | 50.0 | 99.0 | 6000 | 3.00 | 750 | 4.5 | 1.5 ± 0.3 | VDRH14V175xyE |
| | | | 455 | 100.0 | 190.0 | 10 000 | 5.00 | 1500 | 4.9 | 1.7 ± 0.3 | VDRH20X175ByE |
| 195 | 250 | 300 | 525 | 5.0 | 12.0 | 800 | 0.10 | 80 | 4.3 | 1.4 ± 0.8 | VDRH05E195xyE |
| | | | 505 | 10.0 | 26.0 | 1750 | 1.00 | 210 | 4.3 | 1.4 ± 0.8 | VDRH07K195xyE |
| | | | 505 | 25.0 | 52.0 | 3500 | 1.50 | 380 | 4.8 | 1.6 ± 0.8 | VDRH10S195xyE |
| | | | 505 | 50.0 | 105.0 | 6000 | 3.00 | 690 | 4.8 | 1.6 ± 0.8 | VDRH14V195xyE |
| | | | 505 | 100.0 | 210.0 | 10 000 | 5.00 | 1350 | 5.1 | 1.9 ± 0.8 | VDRH20X195ByE |



| ELECTRICAL DATA AND ORDERING INFORMATION | | | | | | | | | | | |
|--|--------|--------------------------------|-----------------------------------|-------|--|--|---|------------------------------|----------|-----------|---|
| MAXIMUM CONTINUOUS VOLTAGE | | VOLTAGE ⁽³⁾ AT 1 mA | MAXIMUM VOLTAGE AT STATED CURRENT | | MAXIMUM ENERGY ⁽⁴⁾ (10 x 1000 μs) | MAXIMUM NON-REP. TRANSIENT CURRENT ⁽⁵⁾ I _{NRP} (8 x 20 μs) | NOMINAL DISCHARGE CURRENT ⁽⁷⁾ I _N | TYPICAL CAPACITANCE AT 1 kHz | T (max.) | E | SAP MATERIAL AND ORDERING NUMBER ⁽¹⁾ xy ⁽⁶⁾ |
| RMS ⁽²⁾ (V) | DC (V) | (V) | V (V) | I (A) | (J) | (A) | (kA) | (pF) | (mm) | (mm) | |
| 210 | 275 | 330 | 575 | 5.0 | 13.0 | 800 | 0.10 | 75 | 4.4 | 1.6 ± 0.8 | VDRH05E210xyE |
| | | | 550 | 10.0 | 28.0 | 1750 | 1.00 | 190 | 4.4 | 1.6 ± 0.8 | VDRH07K210xyE |
| | | | 550 | 25.0 | 58.0 | 3500 | 1.50 | 350 | 4.8 | 1.8 ± 0.8 | VDRH10S210xyE |
| | | | 550 | 50.0 | 115.0 | 6000 | 3.00 | 610 | 4.8 | 1.8 ± 0.8 | VDRH14V210xyE |
| | | | 550 | 100.0 | 228.0 | 10 000 | 5.00 | 1250 | 5.3 | 2.0 ± 0.8 | VDRH20X210ByE |
| 230 | 300 | 360 | 620 | 5.0 | 16.0 | 800 | 0.10 | 70 | 4.6 | 1.7 ± 0.8 | VDRH05E230xyE |
| | | | 595 | 10.0 | 32.0 | 1750 | 1.00 | 170 | 4.6 | 1.7 ± 0.8 | VDRH07K230xyE |
| | | | 595 | 25.0 | 65.0 | 3500 | 1.50 | 320 | 5.1 | 1.9 ± 0.8 | VDRH10S230xyE |
| | | | 595 | 50.0 | 130.0 | 6000 | 3.00 | 540 | 5.1 | 1.9 ± 0.8 | VDRH14V230xyE |
| | | | 595 | 100.0 | 255.0 | 10 000 | 5.00 | 1100 | 5.4 | 2.2 ± 0.8 | VDRH20X230ByE |
| 250 | 320 | 390 | 675 | 5.0 | 17.0 | 800 | 0.10 | 60 | 4.8 | 1.9 ± 0.8 | VDRH05E250xyE |
| | | | 650 | 10.0 | 35.0 | 1750 | 1.00 | 160 | 4.8 | 1.9 ± 0.8 | VDRH07K250xyE |
| | | | 650 | 25.0 | 70.0 | 3500 | 1.50 | 300 | 5.1 | 2.1 ± 0.8 | VDRH10S250xyE |
| | | | 650 | 50.0 | 140.0 | 6000 | 3.00 | 480 | 5.1 | 2.1 ± 0.8 | VDRH14V250xyE |
| | | | 650 | 100.0 | 275.0 | 10 000 | 5.00 | 960 | 5.5 | 2.3 ± 0.8 | VDRH20X250ByE |
| 275 | 350 | 430 | 745 | 5.0 | 20.0 | 800 | 0.10 | 55 | 4.9 | 2.0 ± 0.8 | VDRH05E275xyE |
| | | | 710 | 10.0 | 40.0 | 1750 | 1.00 | 140 | 4.9 | 2.0 ± 0.8 | VDRH07K275xyE |
| | | | 710 | 25.0 | 80.0 | 3500 | 1.50 | 270 | 5.3 | 2.2 ± 0.8 | VDRH10S275xyE |
| | | | 710 | 50.0 | 155.0 | 6000 | 3.00 | 440 | 5.3 | 2.2 ± 0.8 | VDRH14V275xyE ⁽⁸⁾ |
| | | | 710 | 100.0 | 303.0 | 10 000 | 5.00 | 900 | 5.8 | 2.5 ± 0.8 | VDRH20X275ByE ⁽⁸⁾ |
| 300 | 385 | 470 | 810 | 5.0 | 21.0 | 800 | 0.10 | 50 | 5.1 | 2.2 ± 0.8 | VDRH05E300xyE |
| | | | 775 | 10.0 | 42.0 | 1750 | 1.00 | 130 | 5.1 | 2.2 ± 0.8 | VDRH07K300xyE |
| | | | 775 | 25.0 | 85.0 | 3500 | 3.00 | 240 | 5.5 | 2.4 ± 0.8 | VDRH10S300xyE |
| | | | 775 | 50.0 | 175.0 | 6000 | 3.00 | 400 | 5.5 | 2.4 ± 0.8 | VDRH14V300xyE ⁽⁸⁾ |
| | | | 775 | 100.0 | 350.0 | 10 000 | 5.00 | 810 | 5.9 | 2.7 ± 0.8 | VDRH20X300ByE ⁽⁸⁾ |
| 320 | 420 | 510 | 880 | 5.0 | 22.0 | 800 | 0.10 | 45 | 5.5 | 2.4 ± 0.8 | VDRH05E320xyE |
| | | | 842 | 10.0 | 45.0 | 1750 | 1.00 | 120 | 5.5 | 2.4 ± 0.8 | VDRH07K320xyE |
| | | | 842 | 25.0 | 92.0 | 3500 | 3.00 | 220 | 6.0 | 2.6 ± 0.8 | VDRH10S320xyE |
| | | | 842 | 50.0 | 190.0 | 6000 | 3.00 | 370 | 6.0 | 2.6 ± 0.8 | VDRH14V320xyE ⁽⁸⁾ |
| | | | 842 | 100.0 | 382.0 | 10 000 | 5.00 | 750 | 6.3 | 2.9 ± 0.8 | VDRH20X320ByE ⁽⁸⁾ |
| 350 | 460 | 560 | 940 | 5.0 | 25.0 | 800 | 0.10 | 42 | 5.8 | 2.7 ± 0.8 | VDRH05E350xyE |
| | | | 920 | 10.0 | 51.0 | 1750 | 1.00 | 110 | 5.8 | 2.7 ± 0.8 | VDRH07K350xyE |
| | | | 920 | 25.0 | 102.0 | 3500 | 3.00 | 200 | 6.1 | 2.9 ± 0.8 | VDRH10S350xyE |
| | | | 920 | 50.0 | 205.0 | 6000 | 3.00 | 320 | 6.1 | 2.9 ± 0.8 | VDRH14V350xyE |
| | | | 920 | 100.0 | 410.0 | 10 000 | 5.00 | 650 | 6.5 | 3.2 ± 0.8 | VDRH20X350ByE |
| 385 | 505 | 620 | 1050 | 5.0 | 27.0 | 800 | 0.10 | 40 | 6.0 | 3.0 ± 0.8 | VDRH05E385xyE |
| | | | 1025 | 10.0 | 54.0 | 1750 | 1.00 | 95 | 6.0 | 3.0 ± 0.8 | VDRH07K385xyE |
| | | | 1025 | 25.0 | 107.0 | 3500 | 3.00 | 180 | 6.5 | 3.2 ± 0.8 | VDRH10S385xyE |
| | | | 1025 | 50.0 | 215.0 | 6000 | 3.00 | 280 | 6.5 | 3.2 ± 0.8 | VDRH14V385xyE |
| | | | 1025 | 100.0 | 420.0 | 10 000 | 5.00 | 570 | 6.8 | 3.5 ± 0.8 | VDRH20X385ByE |



ELECTRICAL CHARACTERISTICS

| ELECTRICAL DATA | | |
|---|----------------|--------------|
| PARAMETER | VALUE | UNIT |
| Maximum continuous voltage: | | |
| RMS | 11 to 680 | V |
| DC | 14 to 895 | V |
| Maximum non-repetitive transient current (I_{NRP}) (8 x 20 μ s) | | |
| VDRH05 | 250 or 800 | A |
| VDRH07 | 500 or 1750 | A |
| VDRH10 | 1000 or 3500 | A |
| VDRH14 | 2000 or 6000 | A |
| VDRH20 | 3000 or 10 000 | A |
| Thermal resistance: | | |
| VDRH05 | \approx 80 | K/W |
| VDRH07 | \approx 70 | K/W |
| VDRH10 | \approx 60 | K/W |
| VDRH14 | \approx 50 | K/W |
| VDRH20 | \approx 40 | K/W |
| Maximum dissipation: | | |
| VDRH05 | 100 | mW |
| VDRH07 | 250 | mW |
| VDRH10 | 400 | mW |
| VDRH14 | 600 | mW |
| VDRH20 | 1000 | mW |
| Temperature coefficient of voltage at 1 mA maximum | \pm 0.05 | %/K |
| Voltage proof between interconnected leads and case | 2500 | V |
| Storage temperature | -40 to +150 | $^{\circ}$ C |
| Operating temperature | -40 to +125 | $^{\circ}$ C |

DERATING CURVE

Maximum Voltage
Maximum Dissipation
Maximum Energy
Maximum Transient Current

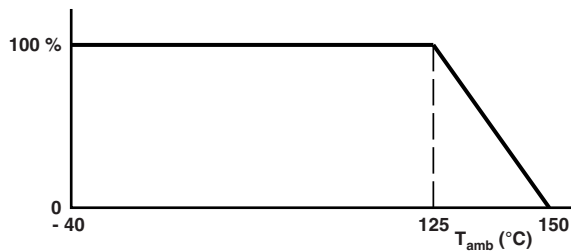

PEAK CURRENT AS A FUNCTION OF PULSE WIDTH

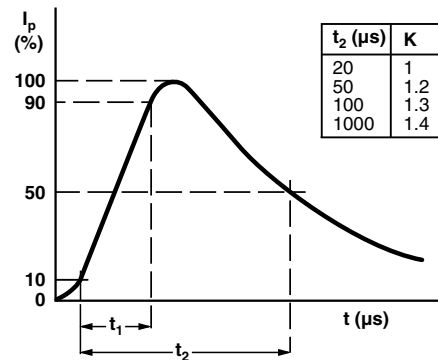

COMPONENT DIMENSIONS (BULK TYPE) in millimeters AND CATALOG NUMBERS

| D MAX. | | A MAX. | | A ₀ MAX. | | L MIN. | T ⁽¹⁾ MAX. | E ⁽¹⁾ | d | F | CATALOG NUMBER |
|----------------|-----------|----------------|-----------|---------------------|-----------|--------|-----------------------|------------------|----------------|---------------|----------------|
| V \leq 320 V | V > 320 V | V \leq 300 V | V > 300 V | V \leq 320 V | V > 320 V | | | | | | |
| 7.0 | | 9.0 | | 11.0 | | 24.0 | 6.5 | 0.7 to 3.6 | 0.6 \pm 0.05 | 5 \pm 1.0 | VDRH05 |
| 9.0 | | 11.0 | | 13.0 | | 24.0 | 6.5 | 0.7 to 3.6 | 0.6 \pm 0.05 | 5 \pm 1.0 | VDRH07 |
| 12.0 | 12.5 | 14.5 | 15.0 | 16.5 | 17.0 | 17.0 | 8.0 | 0.9 to 4.5 | 0.8 \pm 0.05 | 7.5 \pm 1.0 | VDRH10 |
| 16.0 | 16.5 | 19.0 | | 21.0 | 21.5 | 16.0 | 8.0 | 0.9 to 4.5 | 0.8 \pm 0.05 | 7.5 \pm 1.0 | VDRH14 |
| 22.5 | 23.0 | 25.5 | | 27.5 | 28.0 | 24.0 | 10.0 | 1.1 to 5.8 | 1.0 \pm 0.05 | 10 \pm 1.0 | VDRH20 |

Note

⁽¹⁾ T_{max} . and E values per size and voltage level can be found back in the Electrical Data and Ordering Information table

| VARISTORS IN BULK | | | | | |
|---|--|--|---|---|---|
| TYPE | VDRH05.... Ø 5 mm 11 V to 460 V | VDRH07.... Ø 7 mm 11 V to 510 V | VDRH10.... Ø 10 mm 11 V to 680 V | VDRH14.... Ø 14 mm 11 V to 680 V | VDRH20.... Ø 20 mm 11 V to 680 V |
| Straight leads; see outline of components with straight leads drawing | BSE | BSE | BSE | BSE | BSE |
| Kinked leads; see outline of components with kinked leads drawing | BKE | BKE | BKE | BKE | BKE |
| Packaging quantities | | | | | |
| 11 V to 95 V | 250 | 250 | 250 | 100 | 50 |
| 130 V to 385 V | 250 | 250 | 250 | 100 | 50 |
| 420 V to 460 V | 250 | 250 | 200 | 100 | 50 |
| 485 V to max. V | - | 250 | 150 | 100 | 50 |

DIMENSIONS in millimeters: see Component Dimensions and Electrical Data table

OUTLINE of Component with Straight Leads

OUTLINE of Component with Kinked Leads

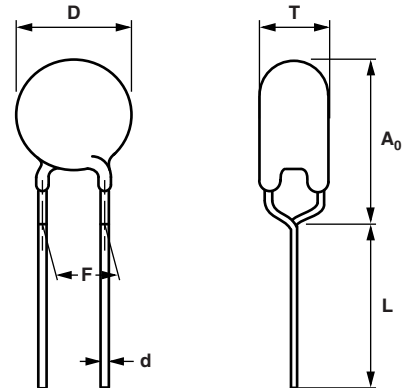
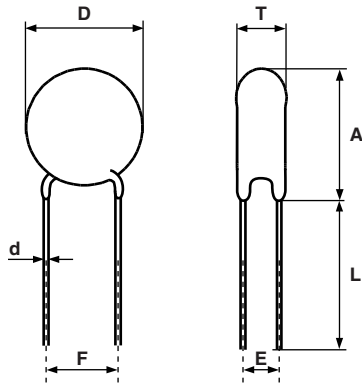

| VARISTORS ON TAPE IN AMMOPACK | | | | |
|---|--|--|---|---|
| TYPE | VDRH05.... Ø 5 mm 11 V to 460 V | VDRH07.... Ø 7 mm 11 V to 510 V | VDRH10.... Ø 10 mm 11 V to 680 V | VDRH14.... Ø 14 mm 11 V to 680 V |
| Straight leads H = 18 mm H = 20 mm See drawing: taped version with straight leads | - | - | ASE | ASE |
| Kinked leads H ₀ = 18.25 mm H ₀ = 16 mm See drawing: taped version with kinked leads | AME | AME | AME | AME |
| | ALE | ALE | ALE | ALE |
| Packaging quantities | | | | |
| 14 V to 210 V | 1500 ⁽¹⁾ | 1500 ⁽¹⁾ | 500 | 500 |
| 230 V to 510 V | 1000 | 1000 | 500 | 500 |
| 550 V to max. V | - | - | 400 | 400 |

Note

⁽¹⁾ Except for 35 V and 40 V = 1000 pieces

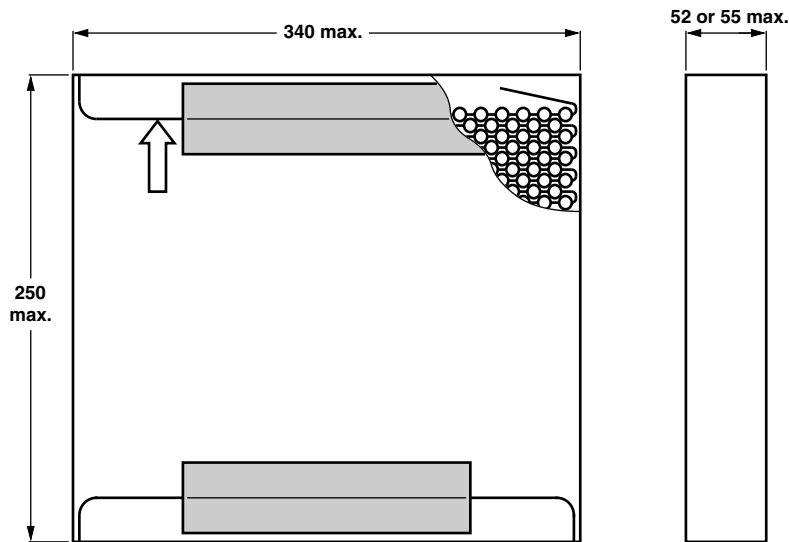
DIMENSIONS OF AMMOPACK in millimeters

| VARISTORS ON TAPE AND REEL | | | | |
|---|---------------------------------------|---------------------------------------|--|--|
| TYPE | VDRH05.... Ø 5 mm 11 V to 460 V | VDRH07.... Ø 7 mm 11 V to 510 V | VDRH10.... Ø 10 mm 11 V to 680 V | VDRH14.... Ø 14 mm 11 V to 680 V |
| H = 18 mm H = 20 mm See drawing: taped version with straight leads | Straight leads - | - | TSE | TSE |
| Kinked leads H ₀ = 18.25 mm H ₀ = 16 mm See drawing: taped version with kinked leads | TME TLE | TME TLE | TME TLE | TME TLE |
| Packaging quantities | | | | |
| 14 V to 250 V | 1500 | 1500 | 1000 | 750 |
| 275 V to 300 V | 1500 | 1500 | 750 | 750 |
| 320 V to 350 V | 1000 | 1000 | 500 | 500 |
| 385 V to max. V | 1000 | 1000 | 500 | 500 |

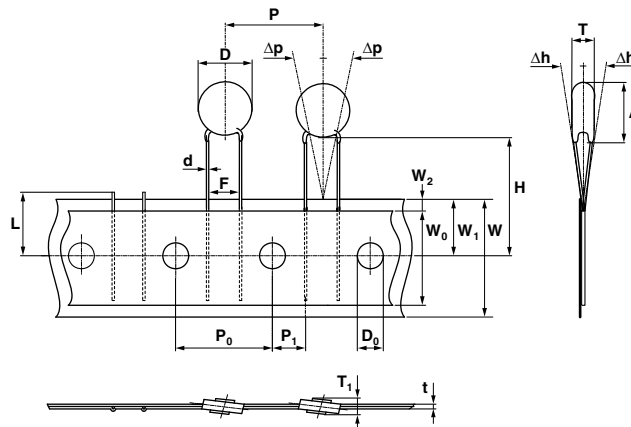
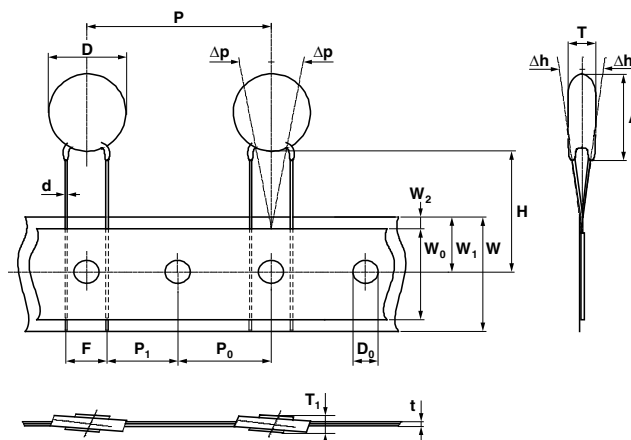
PACKAGING
TAPED VERSION WITH STRAIGHT LEADS (only for VDRH05 and VDRH07)

TAPED VERSION WITH STRAIGHT LEADS (only for VDRH10 and VDRH14)

TAPED VERSION WITH KINKED LEADS

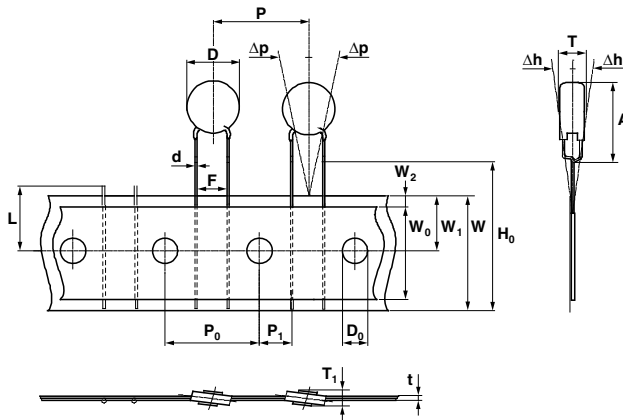
(only for VDRH05 and VDRH07)

TAPED VERSION WITH KINKED LEADS

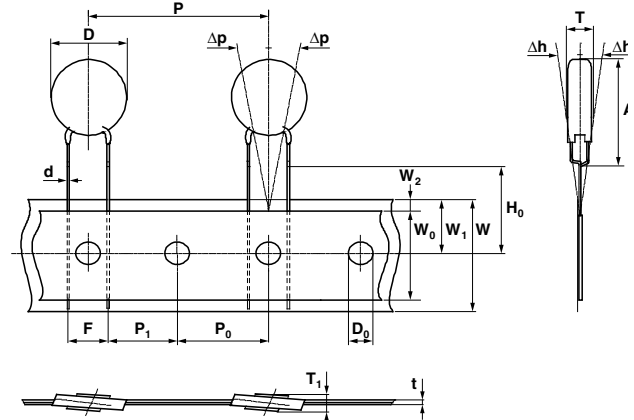
(only for VDRH10 and VDRH14)



| TAPING DATA (based on IEC 60286-2) | | | | | | |
|------------------------------------|--|------------------------|---------------------------|--------|------------------|--------|
| SYMBOL | PARAMETER | | DIMENSIONS/TOLERANCE | | | |
| | | | VDRH05 | VDRH07 | VDRH10 | VDRH14 |
| A max. | Max. mounting height | $V \leq 300 \text{ V}$ | 9.0 | 11.0 | 14.5 | 19.0 |
| | | $V > 300 \text{ V}$ | | | 15.0 | |
| A_0 max. | Max. mounting height | $V \leq 320 \text{ V}$ | 11.0 | 13.0 | 16.5 | 21.0 |
| | | $V > 320 \text{ V}$ | | | 17.0 | 21.5 |
| D max. | Max. body diameter | $V \leq 320 \text{ V}$ | 7.0 | 9.0 | 12.0 | 16.0 |
| | | $V > 320 \text{ V}$ | | | 12.5 | 16.5 |
| d | Lead wire diameter | | 0.6 ± 0.05 | | 0.8 ± 0.05 | |
| F | Lead to lead distance ⁽¹⁾ | | 5.0 + 0.8/- 0.2 | | 7.5 ± 0.8 | |
| H | Distance component to tape center ⁽²⁾ | | 20.0 + 2.0/- 0.0 | | 18.0 + 2.0/- 0.0 | |
| H_0 | Lead wire clinch height | | 16.0 or 18.25 ± 0.5 | | | |
| P | Pitch of components on tape | | 12.7 ± 1.0 | | 25.4 ± 1.0 | |
| T | Total thickness | | See Electrical Data table | | | |

Notes
⁽¹⁾ Guaranteed between component and tape

⁽²⁾ For VDRH14V510xSE and VDRH14V550xSE: H = 20 mm ± 1 mm



V/I CHARACTERISTICS

11 V_{RMS} to 40 V_{RMS}; VDRH05

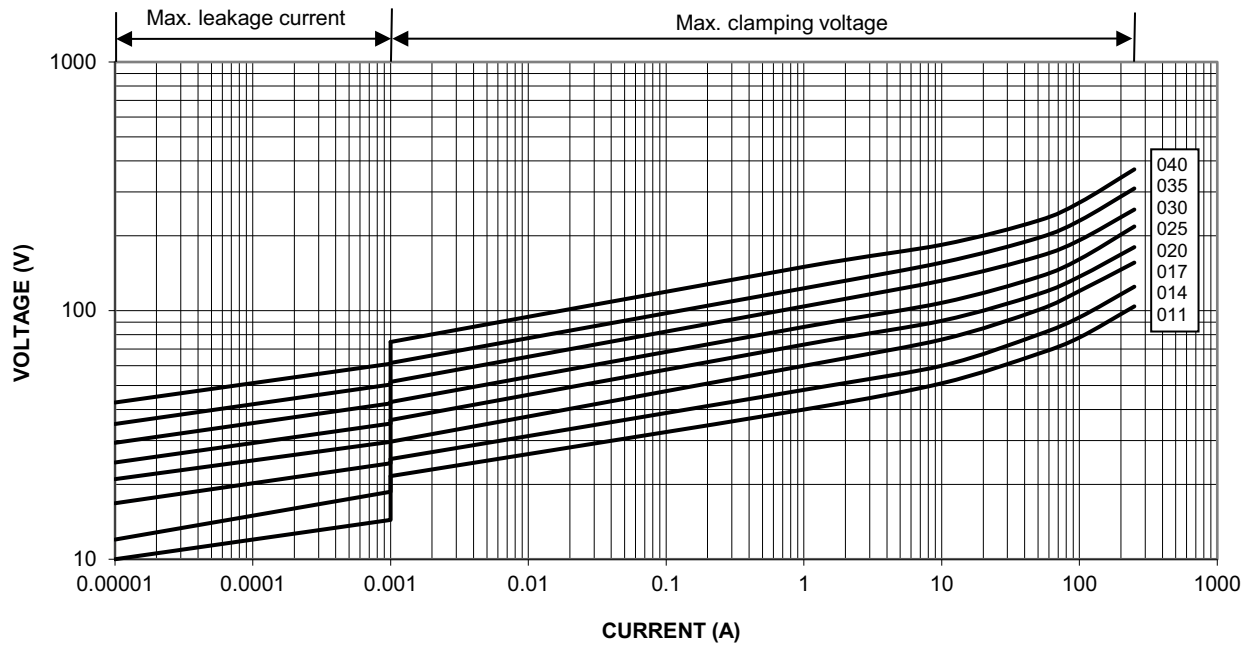

50 V_{RMS} to 195 V_{RMS}; VDRH05

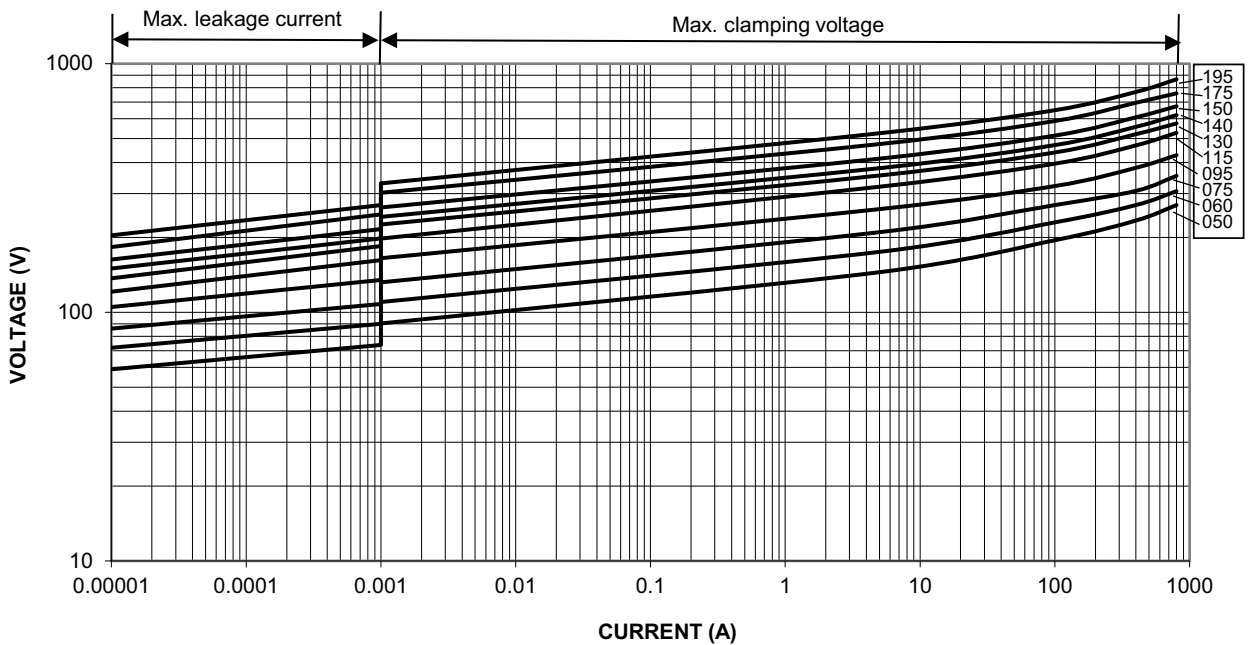



210 V_{RMS} to 460 V_{RMS}; VDRH05

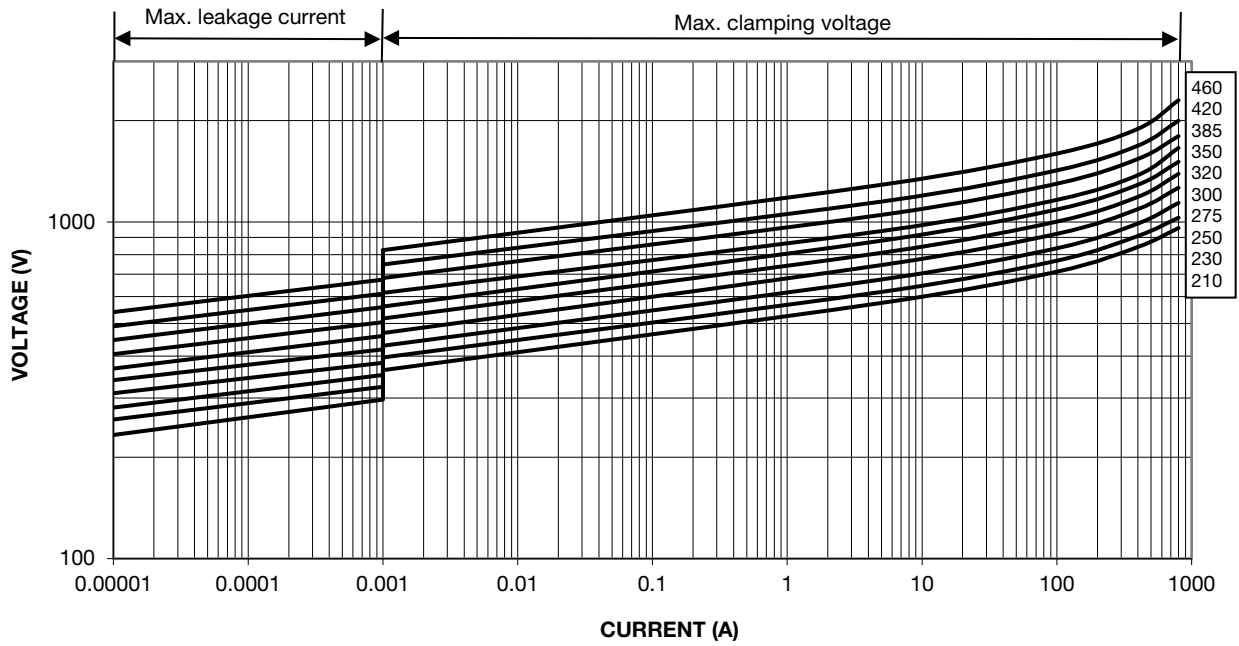

11 V_{RMS} to 40 V_{RMS}; VDRH07

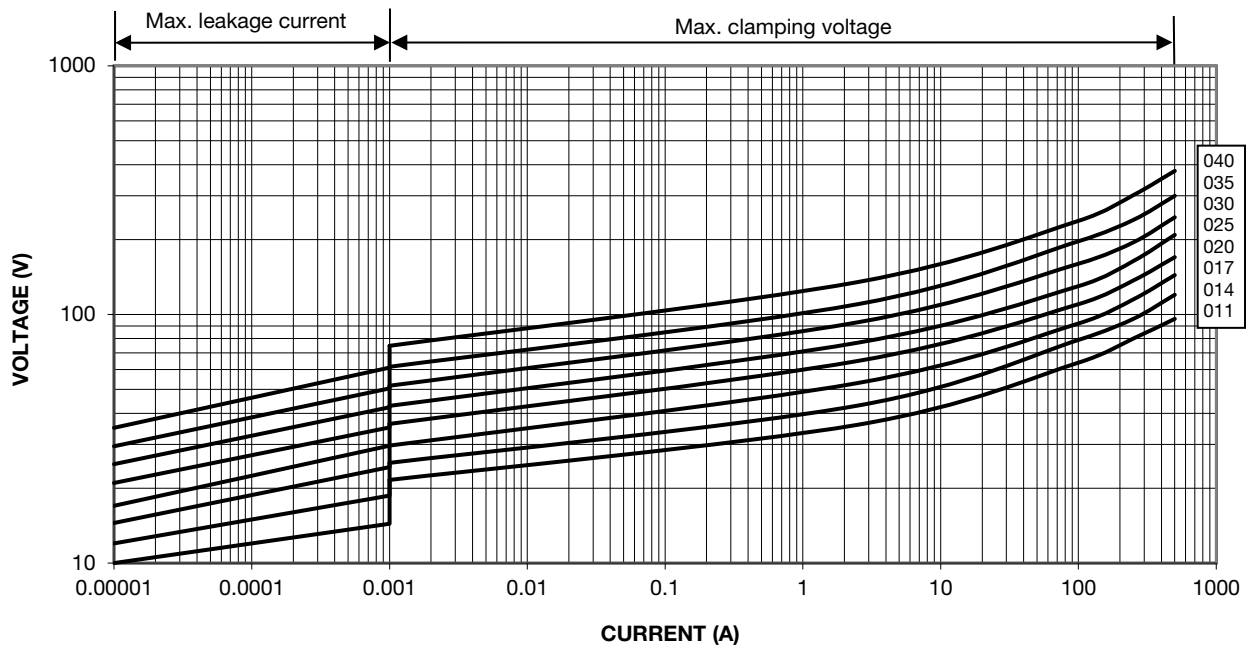



50 V_{RMS} to 210 V_{RMS}; VDRH07

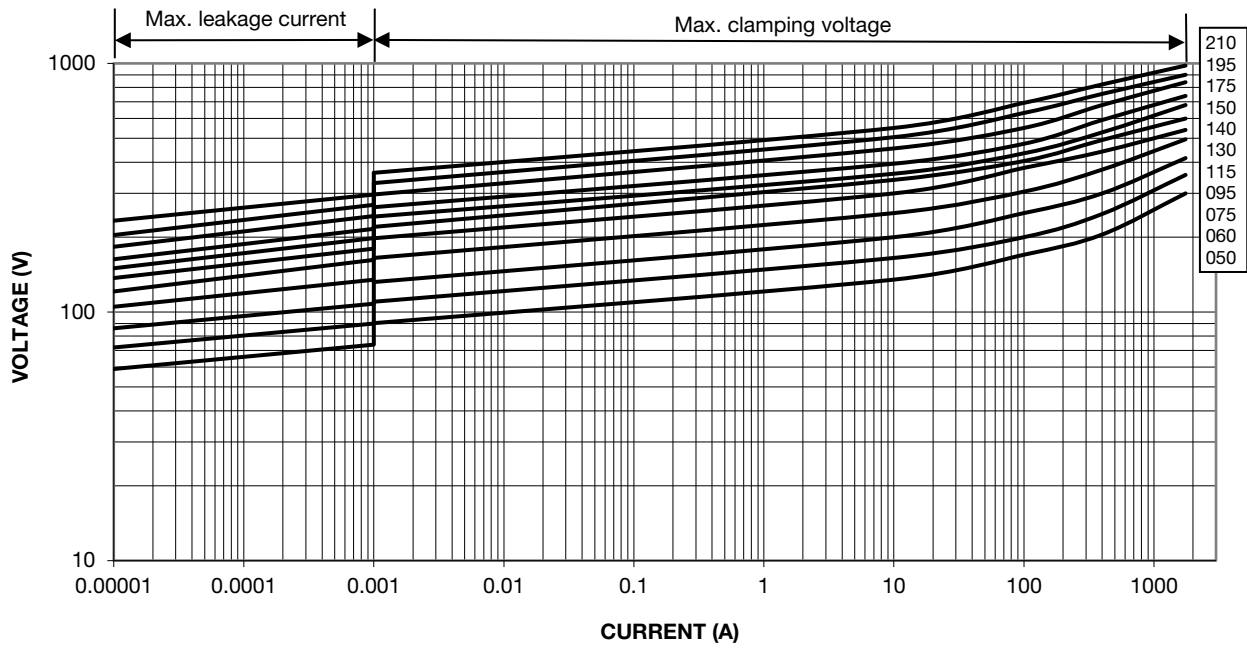

230 V_{RMS} to 510 V_{RMS}; VDRH07

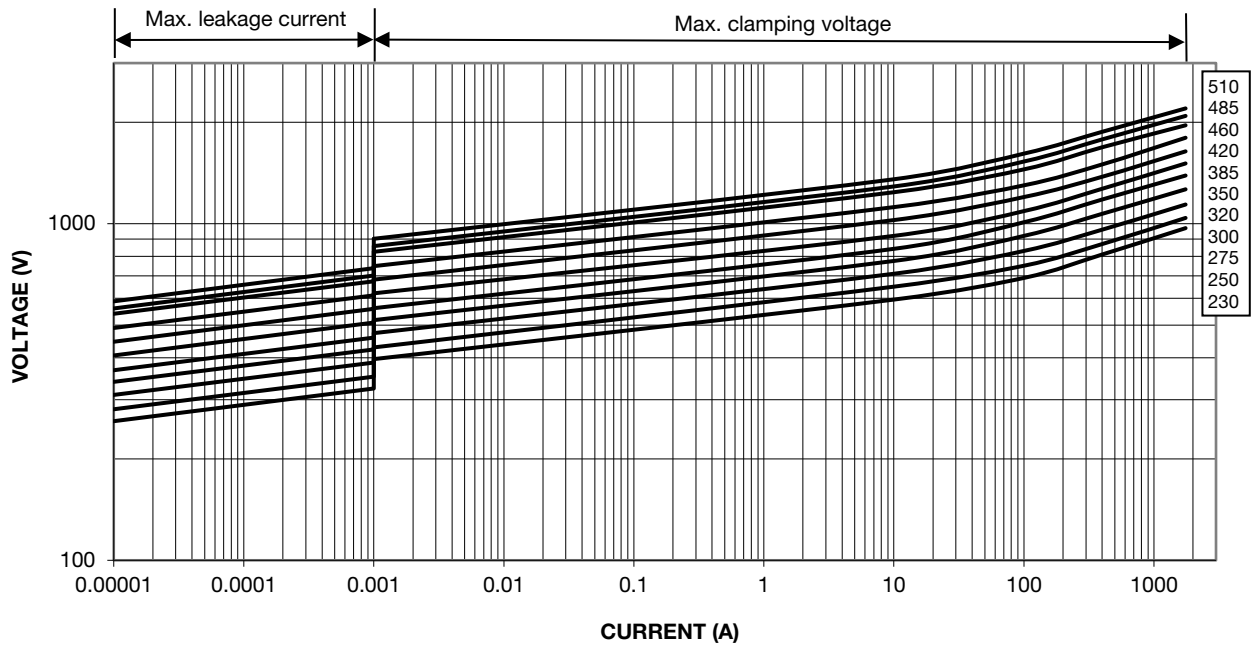



11 V_{RMS} to 40 V_{RMS}; VDRH10

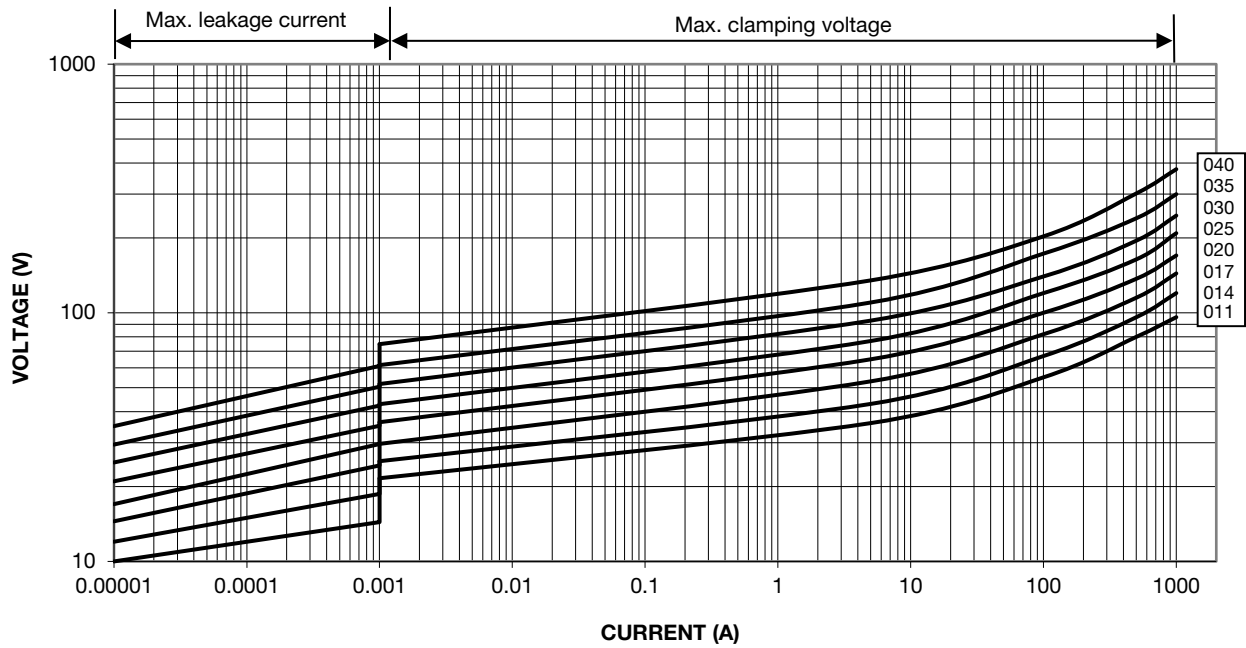

50 V_{RMS} to 210 V_{RMS}; VDRH10

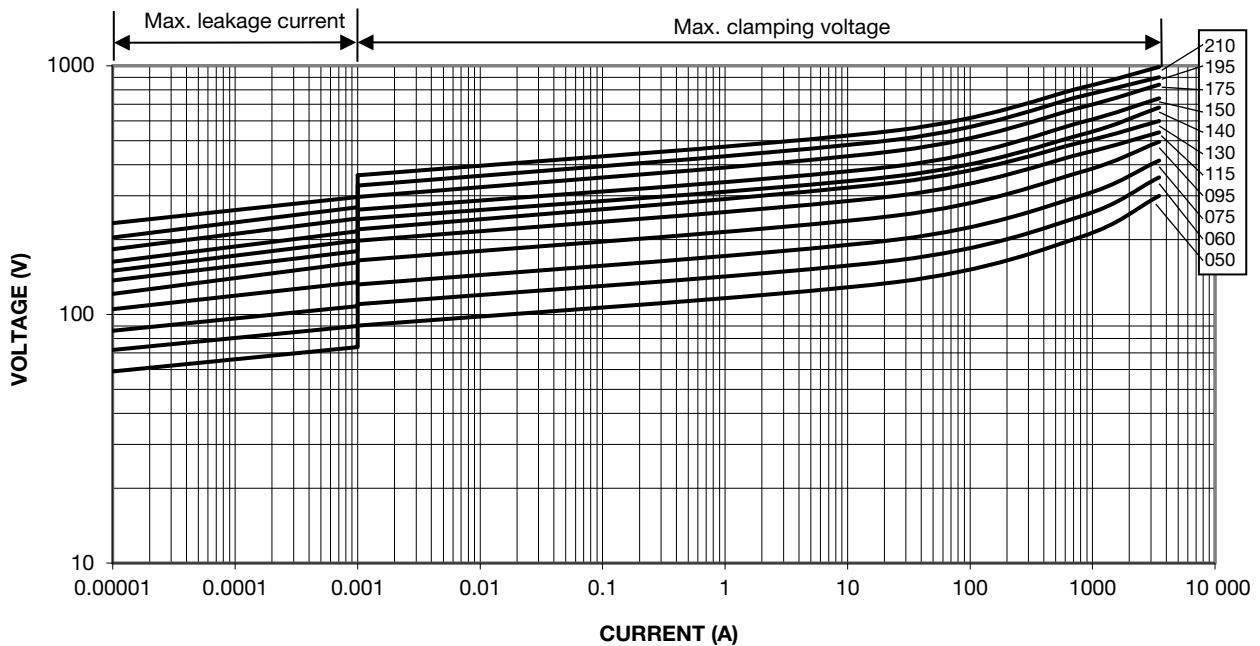



230 V_{RMS} to 680 V_{RMS}; VDRH10

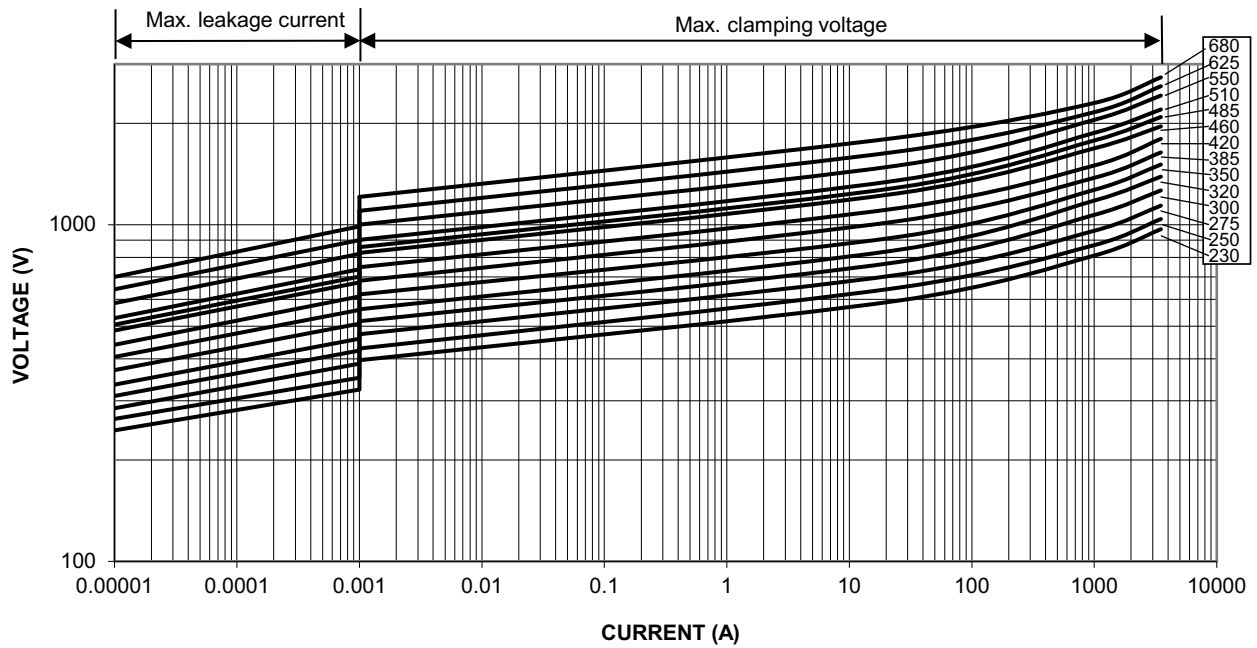

11 V_{RMS} to 40 V_{RMS}; VDRH14

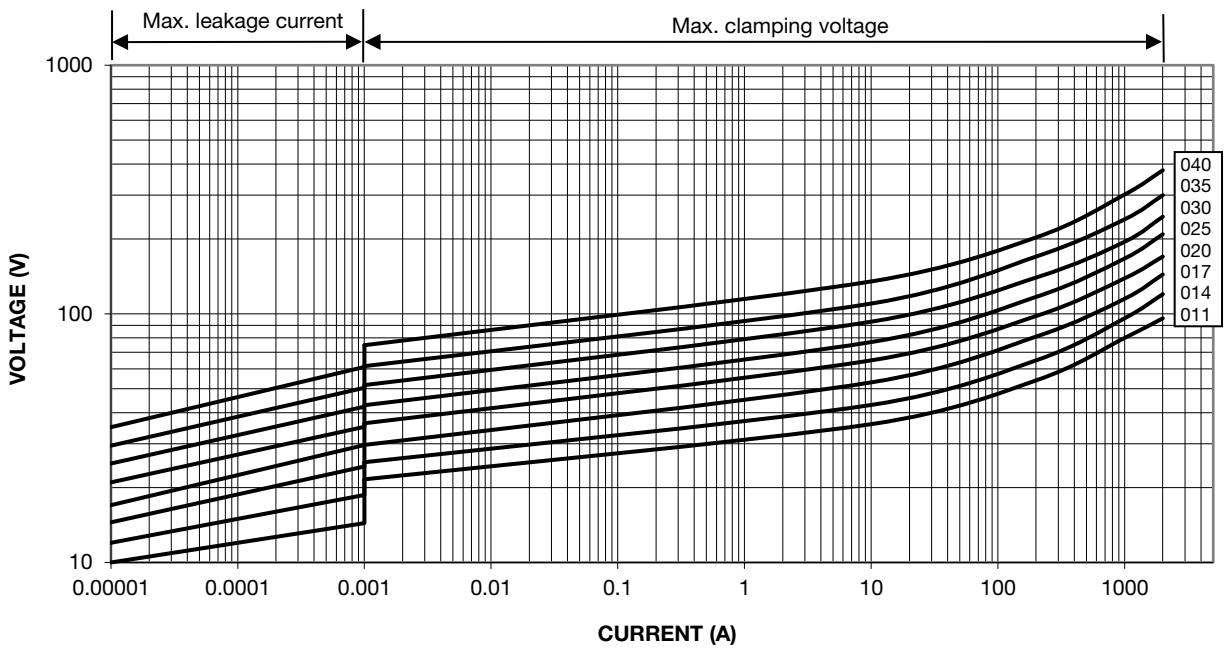



50 V_{RMS} to 210 V_{RMS}; VDRH14

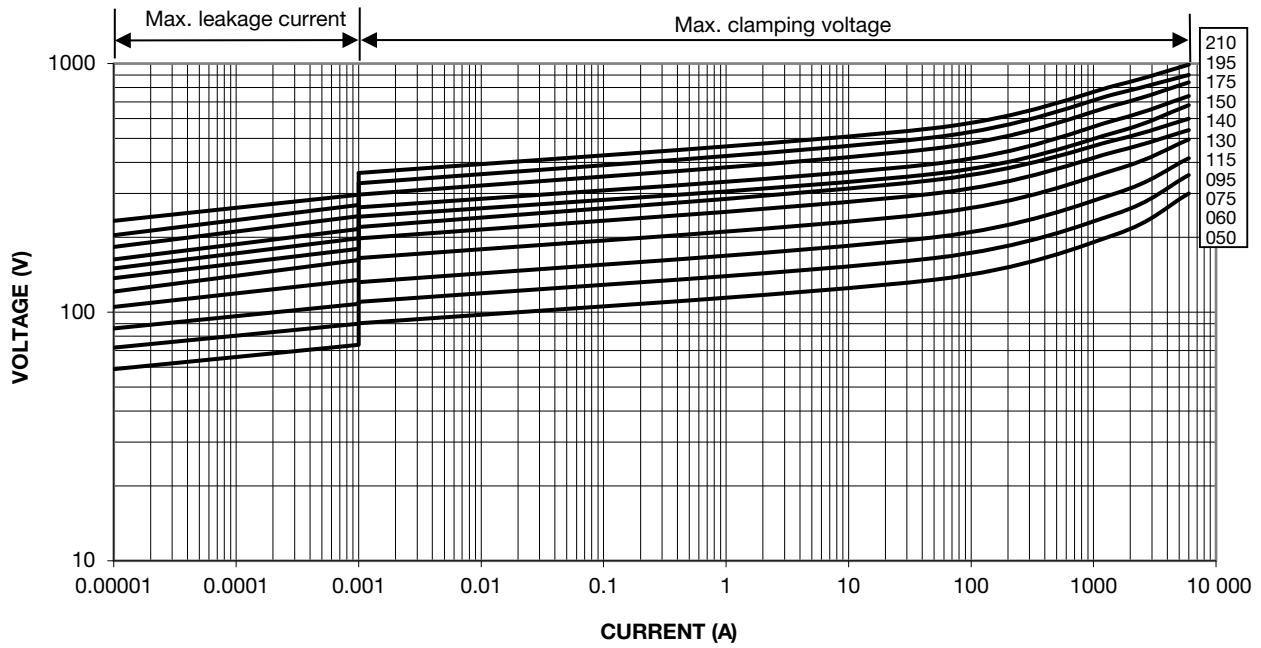

230 V_{RMS} to 680 V_{RMS}; VDRH14

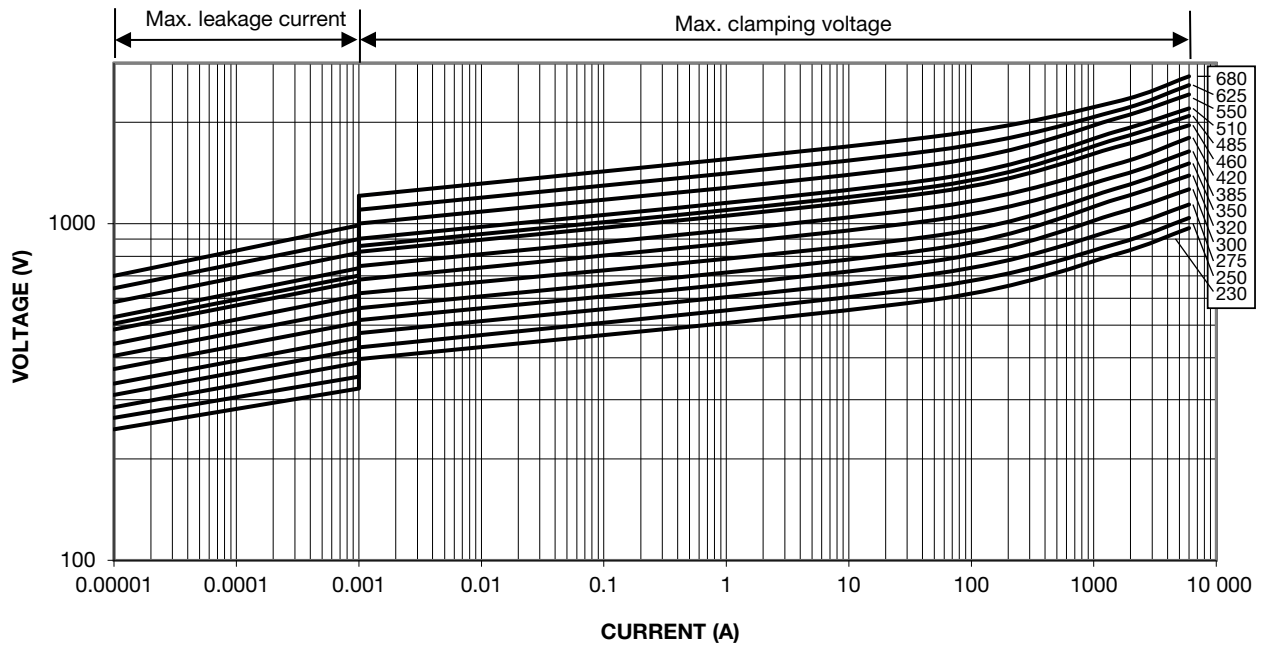



14 V_{RMS} to 40 V_{RMS}; VDRH20

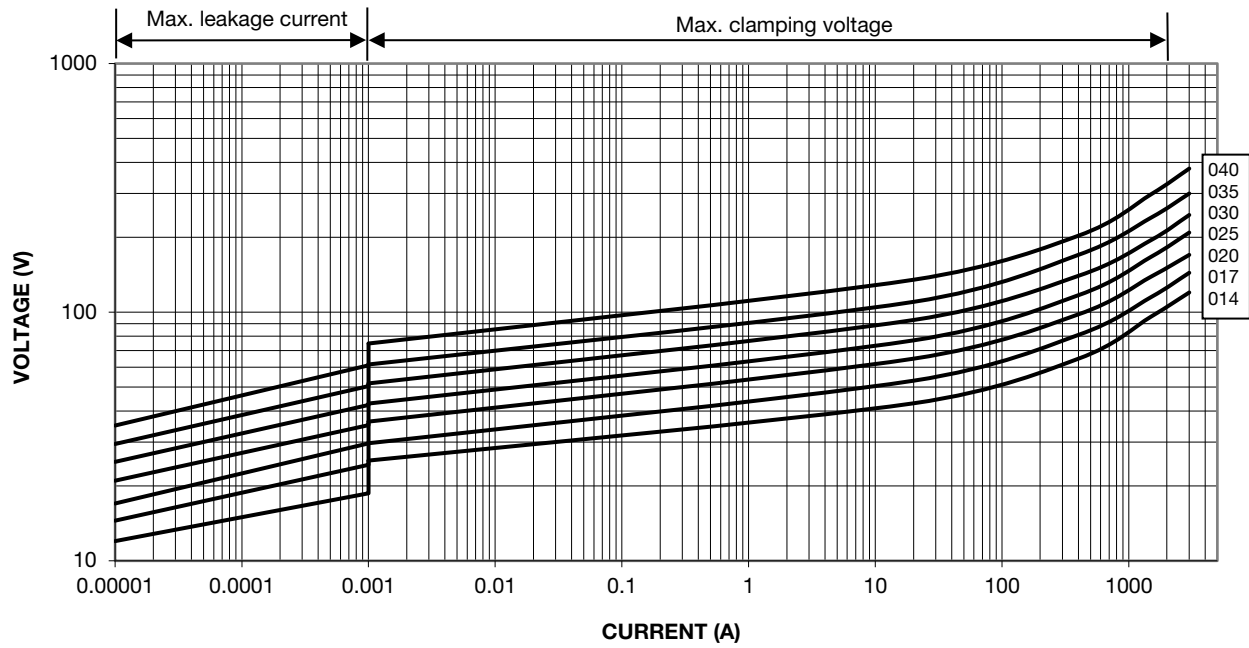

60 V_{RMS} to 210 V_{RMS}; VDRH20

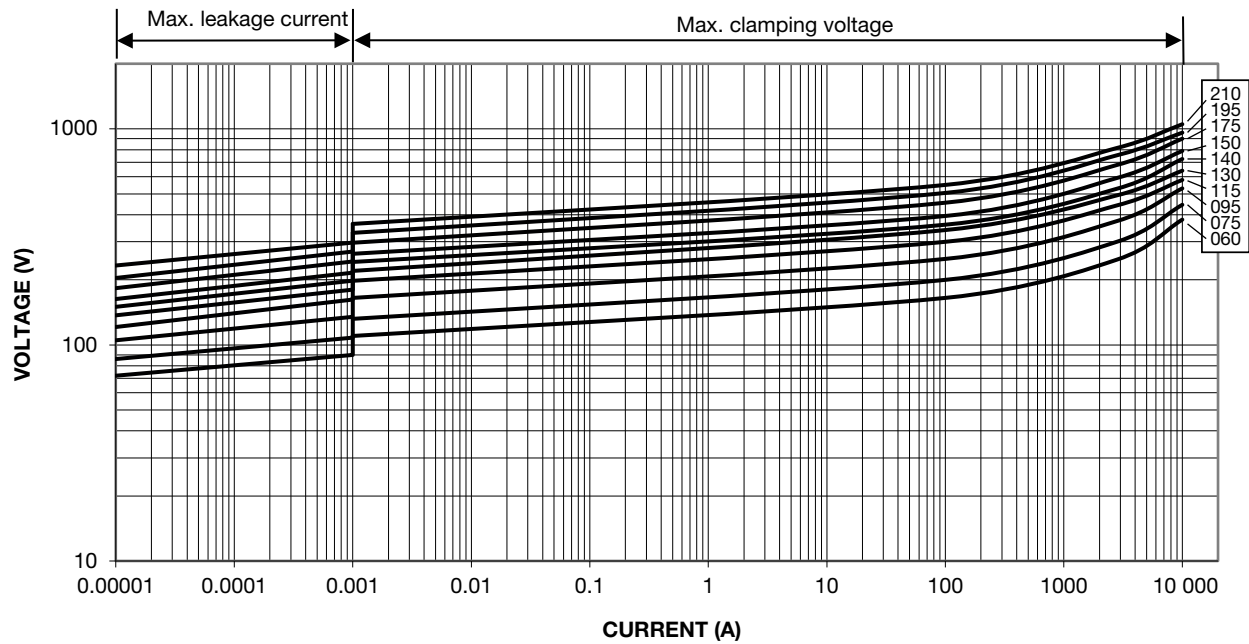



230 V_{RMS} to 680 V_{RMS}; VDRH20

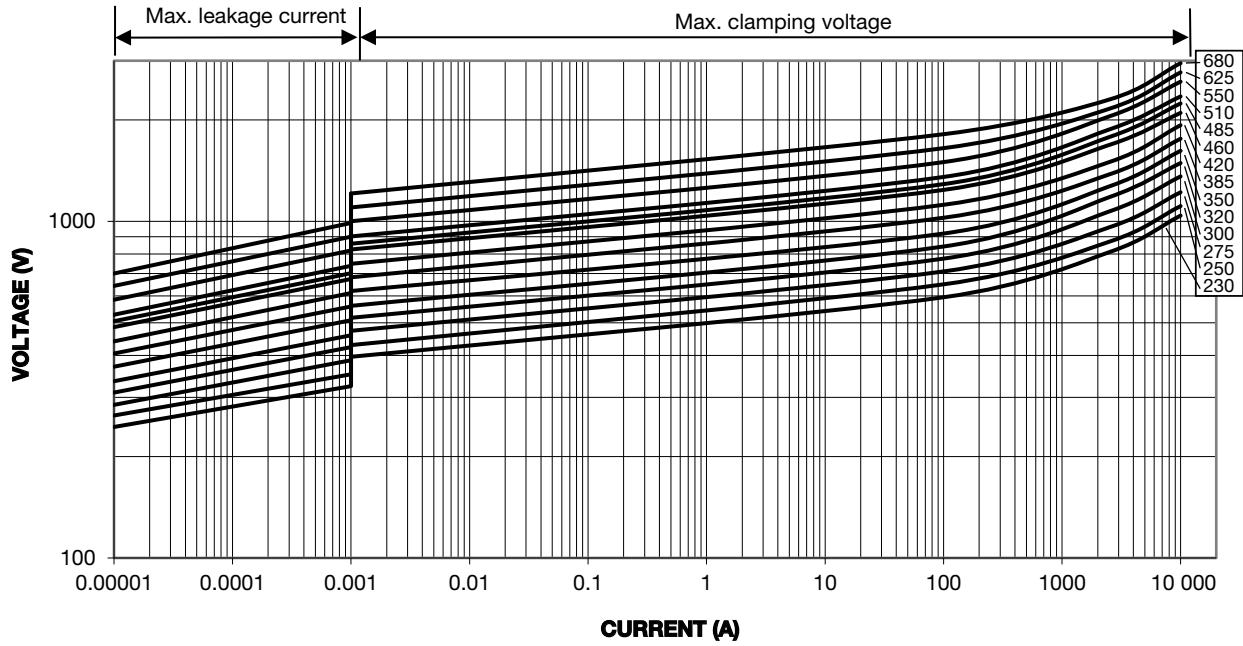

MAXIMUM APPLICABLE TRANSIENT CURRENT AS A FUNCTION OF PULSE DURATION

11 V_{RMS} to 40 V_{RMS}; VDRH05

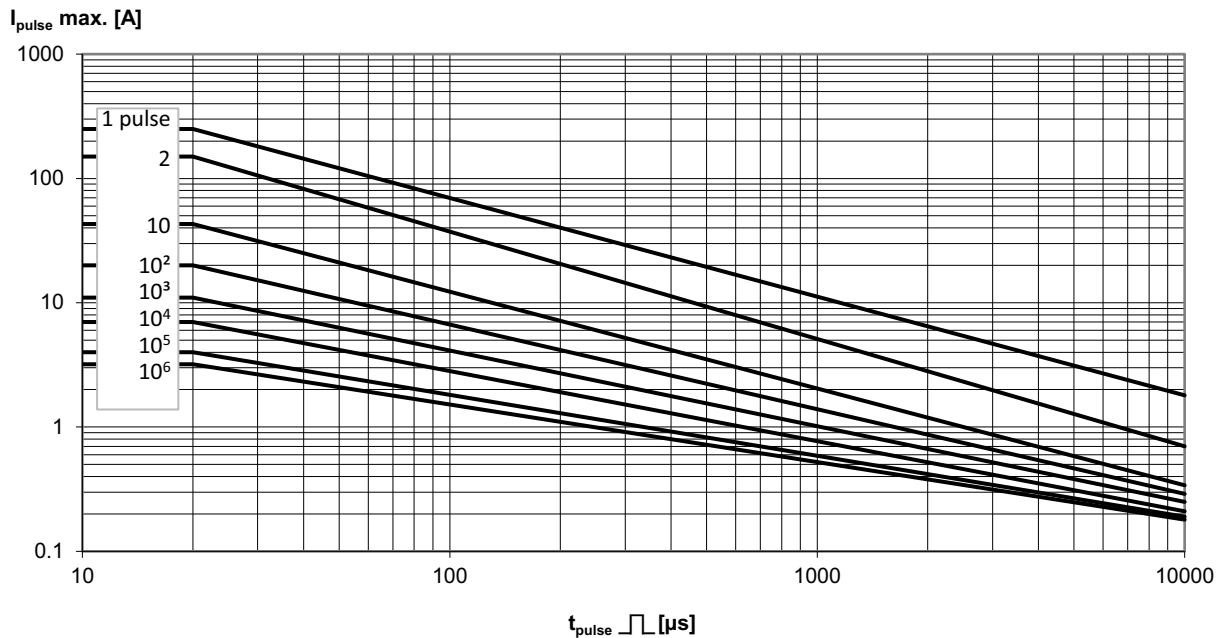



50 V_{RMS} to 460 V_{RMS}; VDRH05

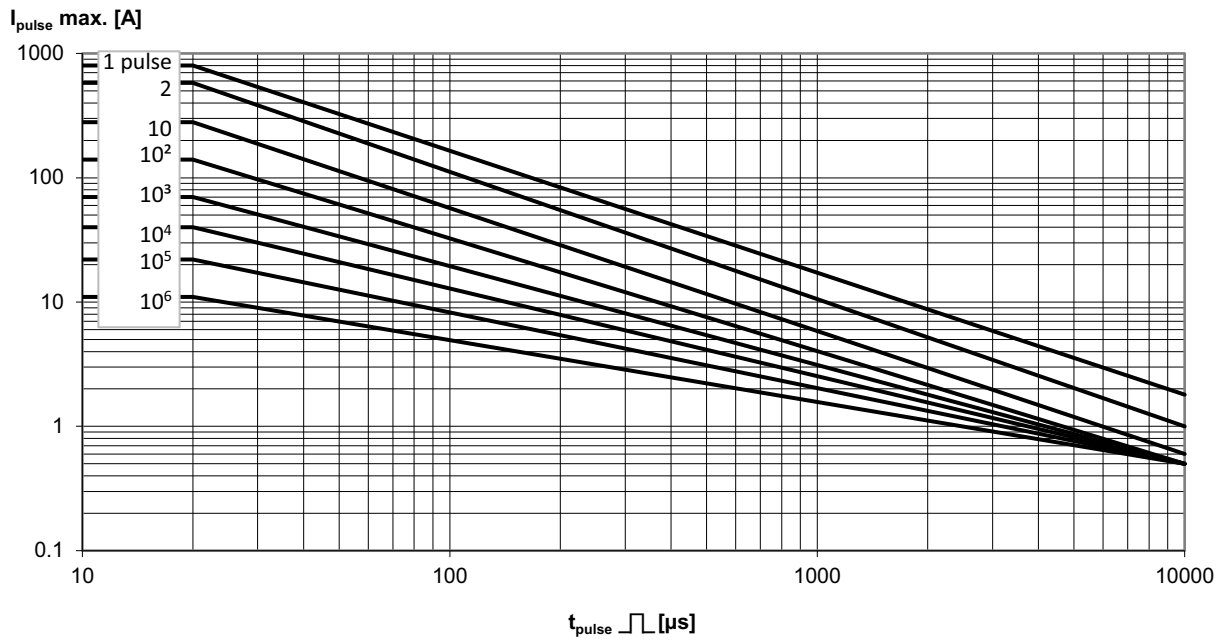

11 V_{RMS} to 40 V_{RMS}; VDRH07

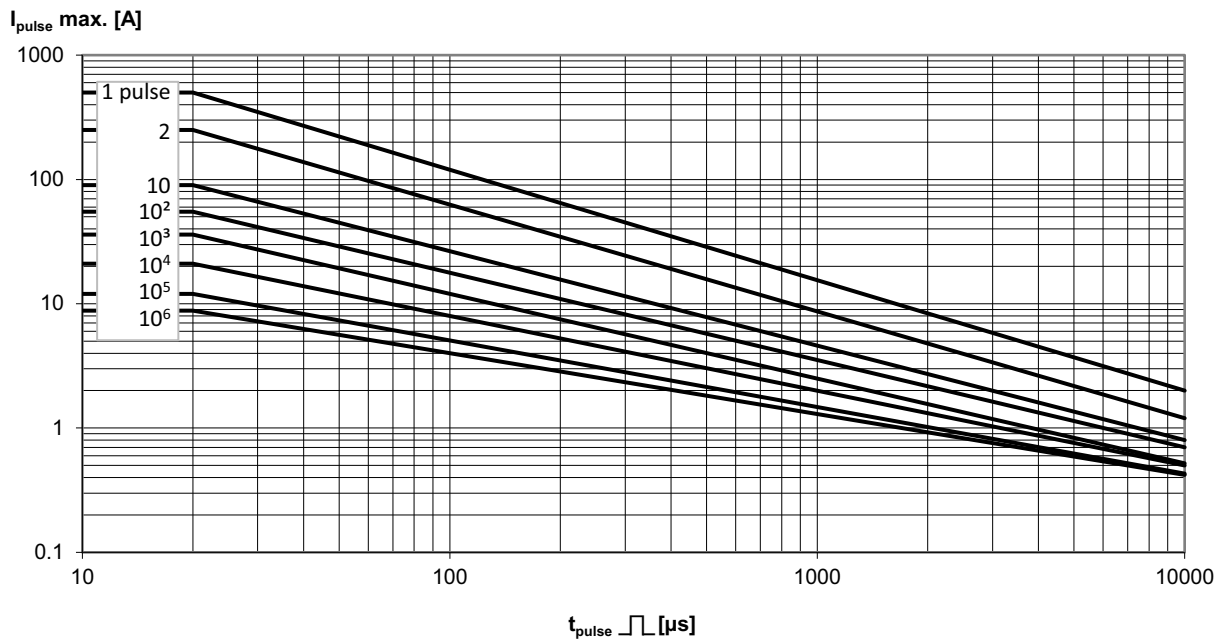



50 V_{RMS} to 510 V_{RMS}; VDRH07

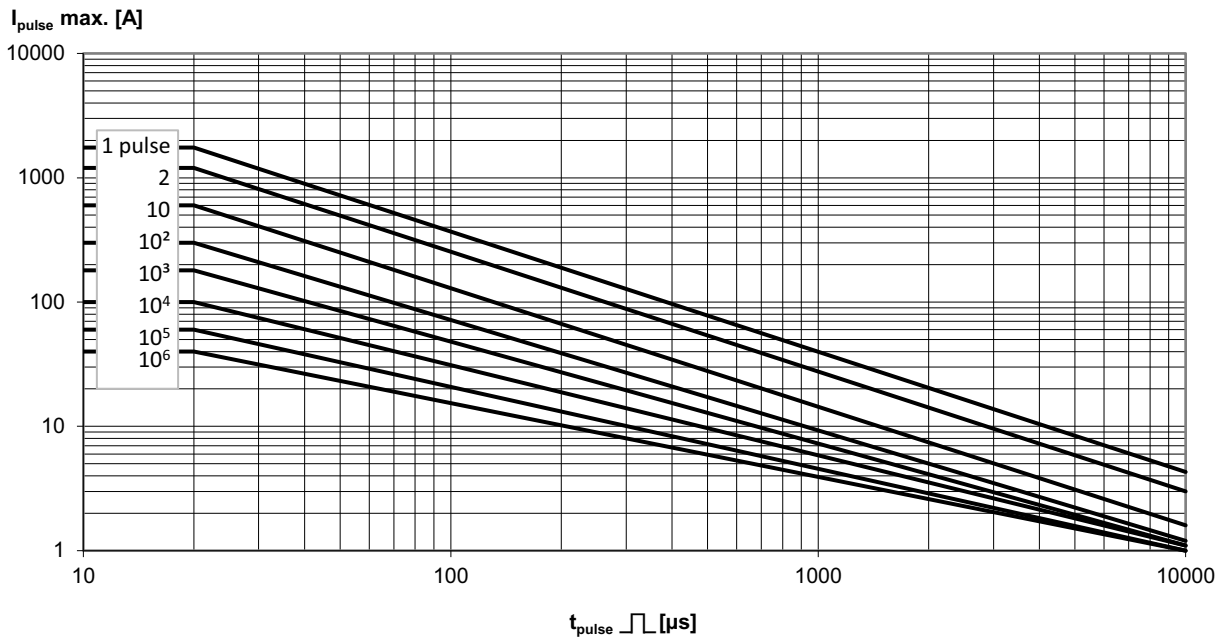

11 V_{RMS} to 40 V_{RMS}; VDRH10

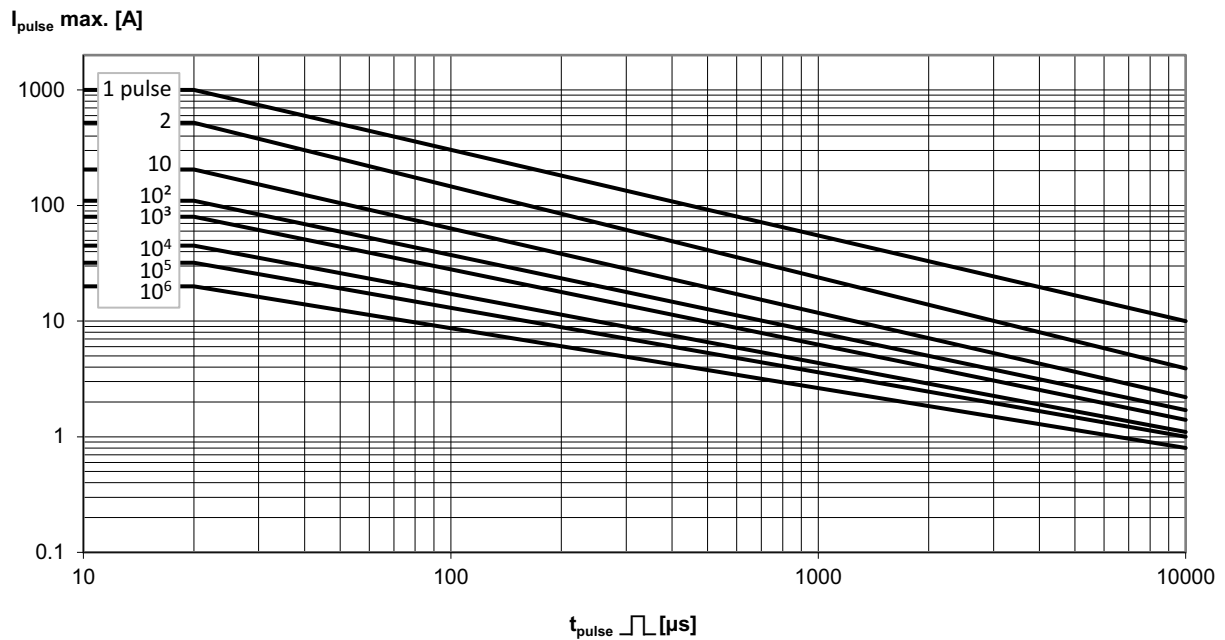



50 V_{RMS} to 300 V_{RMS}; VDRH10

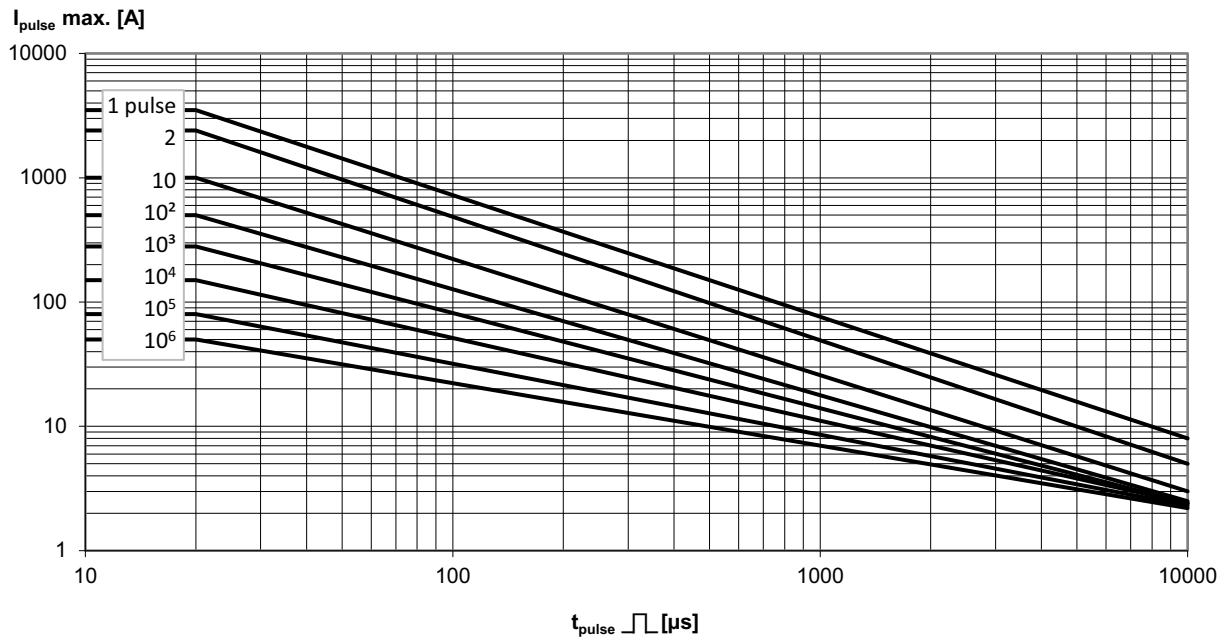

320 V_{RMS} to 680 V_{RMS}; VDRH10

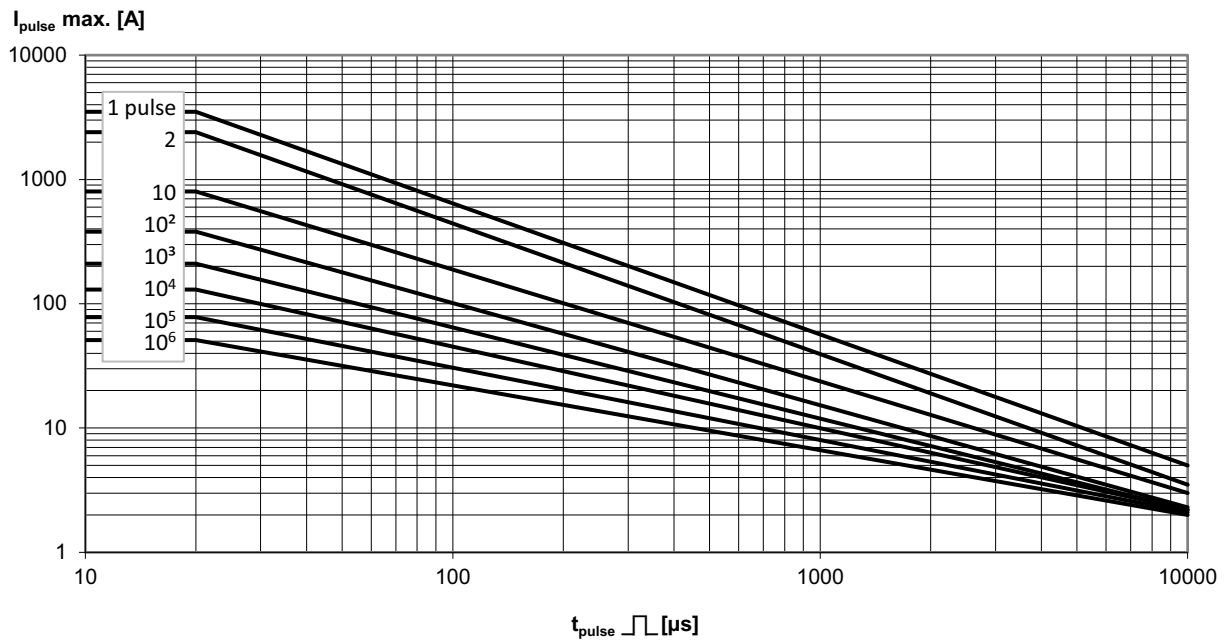



11 V_{RMS} to 40 V_{RMS}; VDRH14

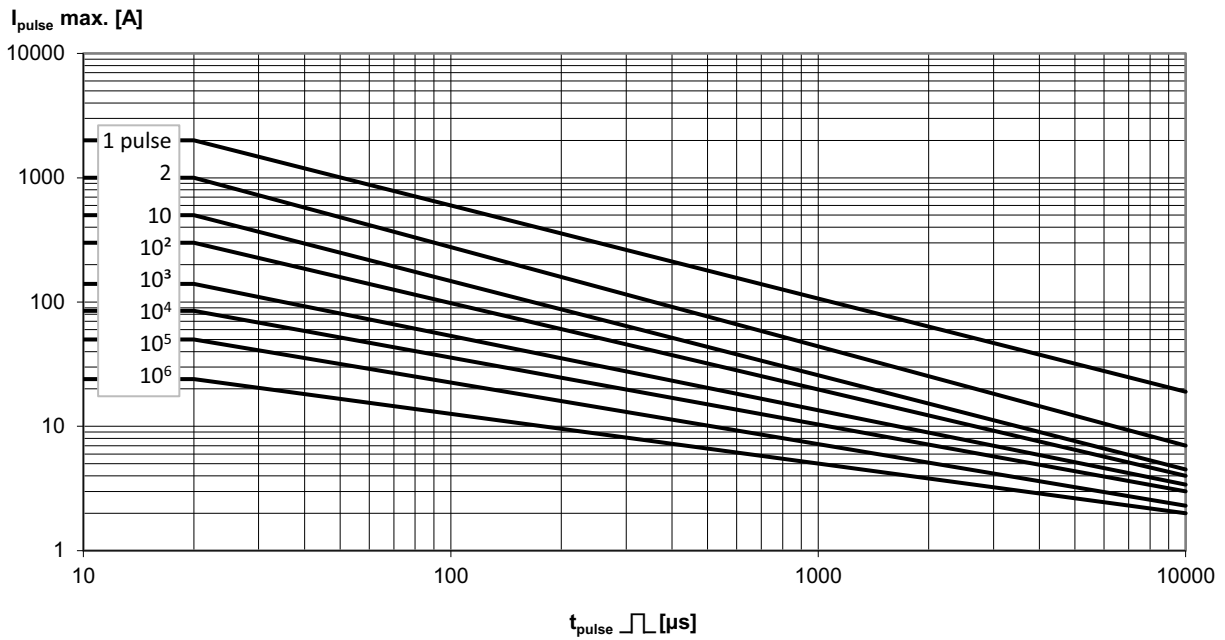

50 V_{RMS} to 300 V_{RMS}; VDRH14

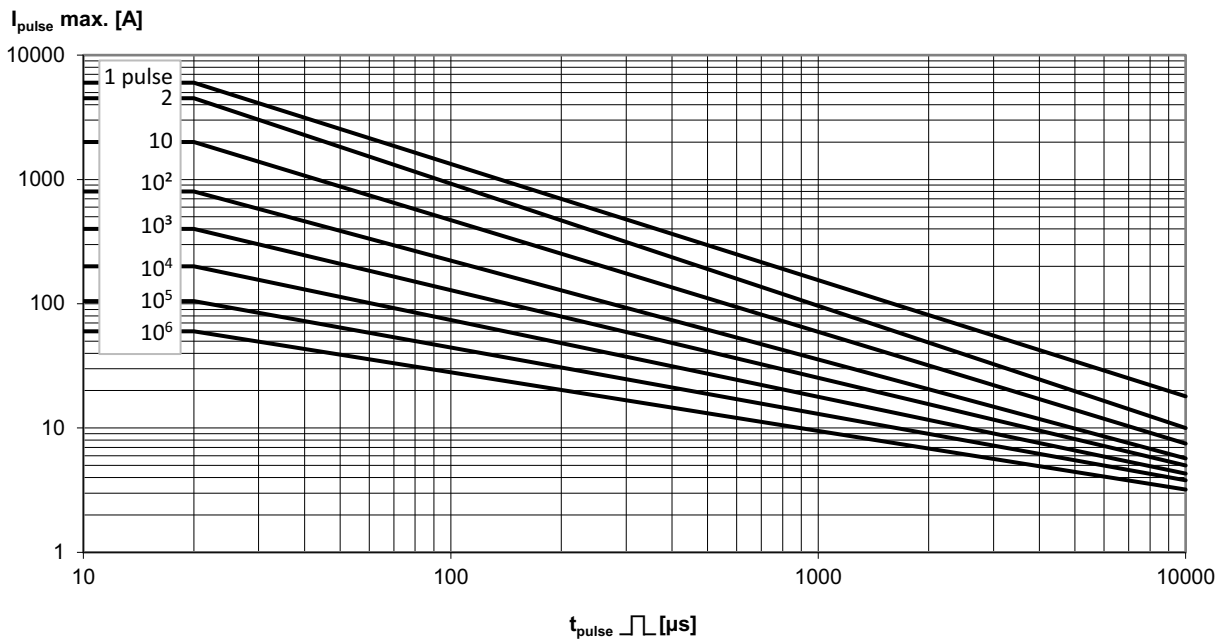



320 V_{RMS} to 680 V_{RMS}; VDRH14

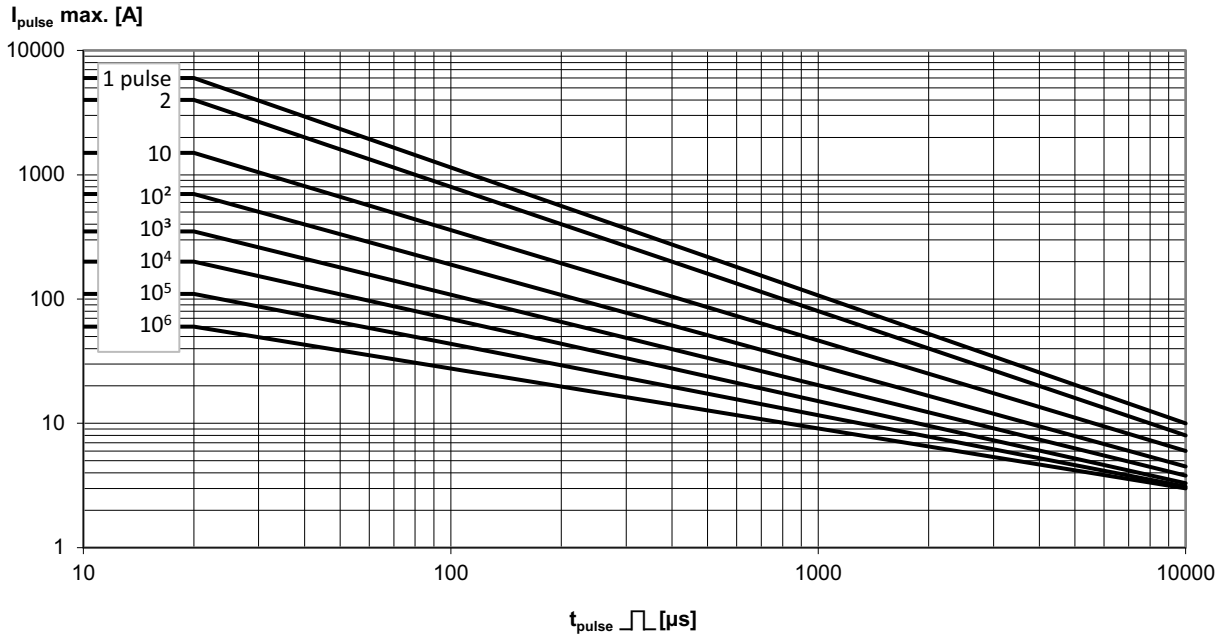

14 V_{RMS} to 40 V_{RMS}; VDRH20

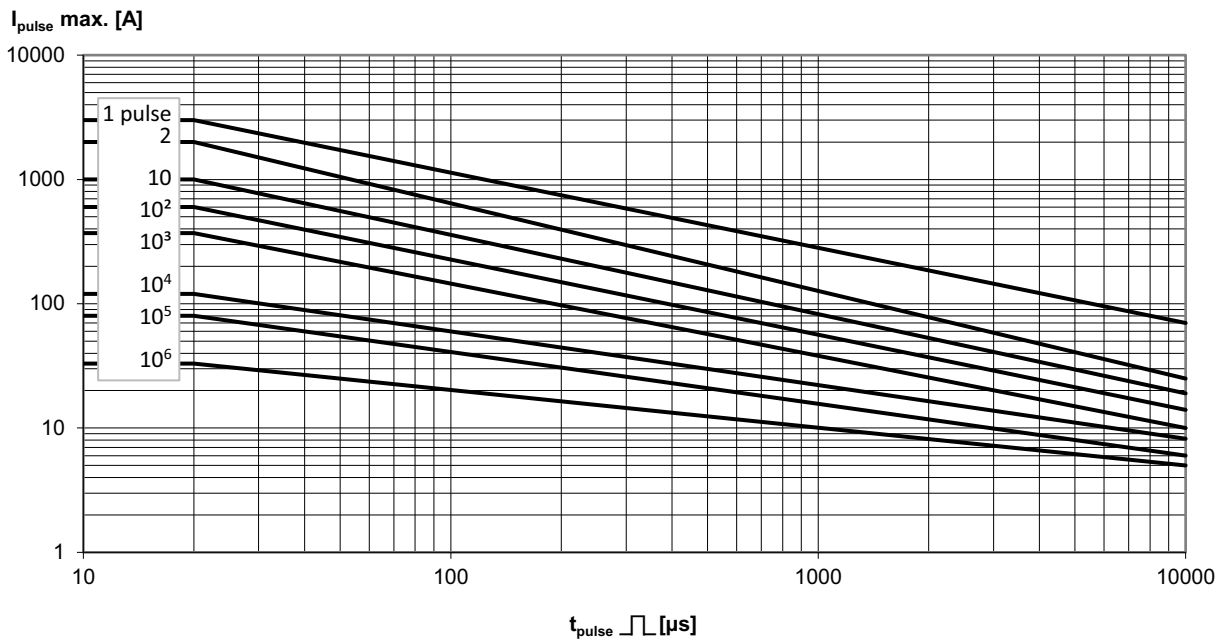



60 V_{RMS} to 300 V_{RMS}; VDRH20

$I_{\text{pulse max. [A]}}$

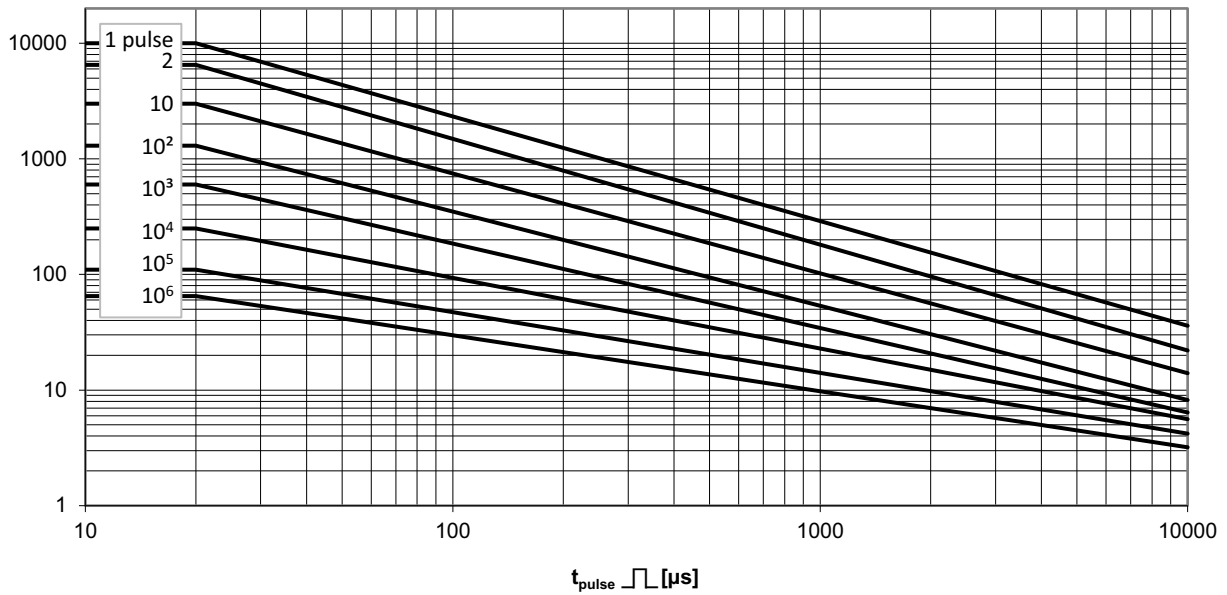

320 V_{RMS} to 680 V_{RMS}; VDRH20

$I_{\text{pulse max. [A]}}$

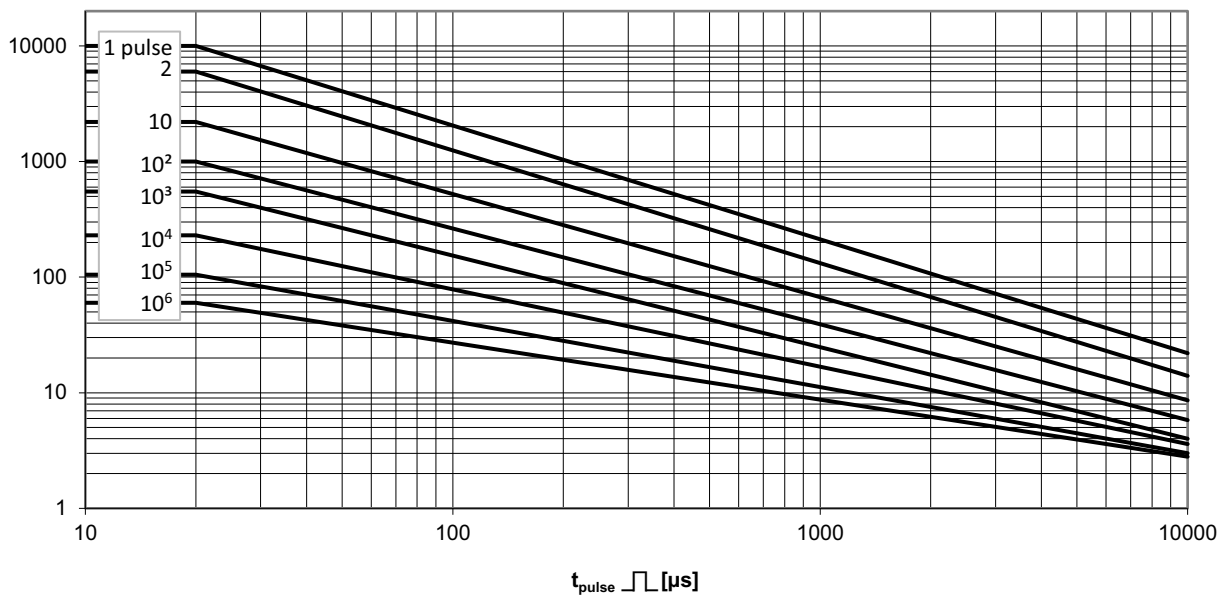



Disclaimer

ALL PRODUCT, PRODUCT SPECIFICATIONS AND DATA ARE SUBJECT TO CHANGE WITHOUT NOTICE TO IMPROVE RELIABILITY, FUNCTION OR DESIGN OR OTHERWISE.

Vishay Intertechnology, Inc., its affiliates, agents, and employees, and all persons acting on its or their behalf (collectively, "Vishay"), disclaim any and all liability for any errors, inaccuracies or incompleteness contained in any datasheet or in any other disclosure relating to any product.

Vishay makes no warranty, representation or guarantee regarding the suitability of the products for any particular purpose or the continuing production of any product. To the maximum extent permitted by applicable law, Vishay disclaims (i) any and all liability arising out of the application or use of any product, (ii) any and all liability, including without limitation special, consequential or incidental damages, and (iii) any and all implied warranties, including warranties of fitness for particular purpose, non-infringement and merchantability.

Statements regarding the suitability of products for certain types of applications are based on Vishay's knowledge of typical requirements that are often placed on Vishay products in generic applications. Such statements are not binding statements about the suitability of products for a particular application. It is the customer's responsibility to validate that a particular product with the properties described in the product specification is suitable for use in a particular application. Parameters provided in datasheets and / or specifications may vary in different applications and performance may vary over time. All operating parameters, including typical parameters, must be validated for each customer application by the customer's technical experts. Product specifications do not expand or otherwise modify Vishay's terms and conditions of purchase, including but not limited to the warranty expressed therein.

Hyperlinks included in this datasheet may direct users to third-party websites. These links are provided as a convenience and for informational purposes only. Inclusion of these hyperlinks does not constitute an endorsement or an approval by Vishay of any of the products, services or opinions of the corporation, organization or individual associated with the third-party website. Vishay disclaims any and all liability and bears no responsibility for the accuracy, legality or content of the third-party website or for that of subsequent links.

Except as expressly indicated in writing, Vishay products are not designed for use in medical, life-saving, or life-sustaining applications or for any other application in which the failure of the Vishay product could result in personal injury or death. Customers using or selling Vishay products not expressly indicated for use in such applications do so at their own risk. Please contact authorized Vishay personnel to obtain written terms and conditions regarding products designed for such applications.

No license, express or implied, by estoppel or otherwise, to any intellectual property rights is granted by this document or by any conduct of Vishay. Product names and markings noted herein may be trademarks of their respective owners.