



Surface Mount Multilayer Ceramic Chip Capacitors for Automotive Applications With Extended Bending Capability



FEATURES

- AEC-Q200 qualified with PPAP available
- Available in 0603, 0805, 1206, and 1210 body size
- Improved bending capability performance: in addition of meeting the bending AEC-Q200 requirements, those capacitors are able to withstand typically more than 5 mm bending
- 100 % matte tin termination for soldering process
- High operating temperature
- Wet build process
- Unique flexible termination system
- Reliable Noble Metal Electrode (NME) system
- Parts compliant with ELV directive
- Material categorization: for definitions of compliance please see www.vishay.com/doc?99912



For more than 25 years Vishay Vitramon has supported the automotive industry with robust, highly reliable MLCCs that have made it a leader in this segment. All Vishay Vitramon MLCCs are manufactured in “Precious Metal Technology” (PMT / NME) and a wet build process. They are qualified according to AEC-Q200 with PPAP available on request. Applications for these devices include automotive “under the hood”, safety and comfort electronics. Their termination finish is 100 % matte tin plate finish. A polymer (flexible) termination with 100 % matte tin plate finish is offered for boardflex sensitive applications.

COG (NP0) DIELECTRIC	
GENERAL SPECIFICATION	
Note Electrical characteristics at +25 °C unless otherwise specified	
Operating Temperature: -55 °C to +150 °C (above +125 °C changed characteristics, see 2.2)	
Capacitance Range: 100 pF to 12 nF	
Voltage Range: 50 V _{DC} to 630 V _{DC}	
Temperature Coefficient of Capacitance (TCC): 0 ppm/°C ± 30 ppm/°C from -55 °C to +125 °C (specific ratings can vary, please contact mlcc@vishay.com for details)	
Dissipation Factor (DF): 0.1 % maximum at 1.0 V _{RMS} and 1 MHz for values ≤ 1000 pF 0.1 % maximum at 1.0 V _{RMS} and 1 kHz for values > 1000 pF	
Insulating Resistance: at +25 °C 100 000 MΩ min. or 1000 ΩF whichever is less at +125 °C 10 000 MΩ min. or 100 ΩF whichever is less	
Aging: 0 % maximum per decade	
Dielectric Strength Test: performed per method 103 of EIA 198-2-E. Applied test voltages	
≤ 250 V _{DC} -rated:	250 % of rated voltage
500 V _{DC} -rated:	200 % of rated voltage
630 V _{DC} -rated:	150 % of rated voltage

X7R, X8R DIELECTRIC	
GENERAL SPECIFICATION	
Note Electrical characteristics at +25 °C unless otherwise specified	
Operating Temperature: -55 °C to +150 °C (X7R above +125 °C changed characteristics, see 2.2)	
Capacitance Range: X7R: 10 nF to 470 nF X8R: 10 nF to 220 nF	
Voltage Range: 16 V _{DC} to 630 V _{DC}	
Temperature Coefficient of Capacitance (TCC): X7R: ± 15 % from -55 °C to +125 °C, with 0 V _{DC} applied X8R: ± 15 % from -55 °C to +150 °C, with 0 V _{DC} applied	
Dissipation Factor (DF): 16 V, 25 V ratings: 3.5 % maximum at 1.0 V _{RMS} and 1 kHz > 25 V ratings: 2.5 % maximum at 1.0 V _{RMS} and 1 kHz	
Insulating Resistance: at +25 °C 100 000 MΩ min. or 1000 ΩF whichever is less at +125 °C 10 000 MΩ min. or 100 ΩF whichever is less X8R: at +150 °C 10 000 MΩ min. or 100 ΩF whichever is less	
Aging Rate: 1 % maximum per decade	
Dielectric Strength Test: performed per method 103 of EIA 198-2-E. Applied test voltages	
≤ 250 V _{DC} -rated:	250 % of rated voltage
500 V _{DC} -rated:	min. 150 % of rated voltage
630 V _{DC} :	min. 120 % of rated voltage



QUICK REFERENCE DATA				
DIELECTRIC	CASE CODE	MAXIMUM VOLTAGE (V)	CAPACITANCE	
			MINIMUM	MAXIMUM
C0G (NP0)	0603	200	100 pF	1.0 nF
	0805	500	100 pF	3.9 nF
	1206	630	100 pF	8.2 nF
	1210	630	100 pF	12 nF
X7R	0603	100	10 nF	150 nF
	0805	200	10 nF	470 nF
	1206	630	10 nF	180 nF
	1210	630	10 nF	180 nF
X8R	0603	50	10 nF	33 nF
	0805	100	10 nF	100 nF
	1206	50	10 nF	220 nF
	1210	50	10 nF	220 nF

Note

- Detail ratings see “Selection Chart”

ORDERING INFORMATION								
GA0805	Y	104	K	W	A	A	T	31G
CASE CODE	DIELECTRIC	CAPACITANCE NOMINAL CODE (1)	CAPACITANCE TOLERANCE	TERMINATION	DC VOLTAGE RATING (2)	MARKING	PACKAGING	PROCESS CODE
0603 0805 1206 1210	A = C0G (NP0) Y = X7R H = X8R	Expressed in picofarads (pF). The first two digits are significant, the third is a multiplier. An “R” indicates a decimal point. Example 102 = 1000 pF	F = ± 1 % G = ± 2 % J = ± 5 % K = ± 10 % M = ± 20 % Note C0G (NP0): F, G, J, K ≥ 10 pF X7R / X8R: J, K, M	W = polymer 100 % matte tin plate finish	J = 16 V X = 25 V A = 50 V B = 100 V C = 200 V E = 500 V L = 630 V	A = unmarked	T = 7" reel / plastic tape R = 11 ¼" / 13" reel / plastic tape	31G = “Green” Automotive MLCC

Notes

- (1) Non-standard values, please contact: mlcc@vishay.com
- (2) DC voltage rating should not be exceeded in application. Other application factors may affect the MLCC performance. Consult for questions: mlcc@vishay.com

DIMENSIONS in inches (millimeters)						
CASE CODE	STYLE	LENGTH (L)	WIDTH (W)	MAXIMUM THICKNESS (T)	TERMINATIONS PAD (P)	
					MINIMUM	MAXIMUM
0603	GA0603	0.071 ± 0.006 (1.80 ± 0.15)	0.033 ± 0.006 (0.85 ± 0.15)	0.039 (1.00)	0.017 (0.43)	0.024 (0.65)
0805	GA0805	0.083 ± 0.012 (2.10 ± 0.30)	0.051 ± 0.010 (1.30 ± 0.25)	0.061 (1.55)	0.017 (0.43)	0.03 (0.9)
1206	GA1206	0.137 ± 0.012 (3.48 ± 0.30)	0.065 ± 0.010 (1.65 ± 0.25)	0.071 (1.80)	0.017 (0.43)	0.035 (1.0)
1210	GA1210	0.137 ± 0.012 (3.48 ± 0.30)	0.100 ± 0.010 (2.55 ± 0.25)	0.071 (1.80)	0.017 (0.43)	0.035 (1.0)



SELECTION CHART																
DIELECTRIC		C0G (NP0)														
STYLE		GA0603			GA0805				GA1206				GA1210			
CASE CODE		0603			0805				1206				1210			
VOLTAGE (V _{DC})		50	100	200	50	100	200	500	50	100	200	500 / 630	50	100	200	500 / 630
VOLTAGE CODE		A	B	C	A	B	C	E	A	B	C	E / L	A	B	C	E / L
CAP. CODE	CAP.															
101	100 pF	•	•	•	•	•	•	•	•	•	•	•	•	•	•	•
121	120 pF	•	•	•	•	•	•	•	•	•	•	•	•	•	•	•
151	150 pF	•	•	•	•	•	•	•	•	•	•	•	•	•	•	•
181	180 pF	•	•	•	•	•	•	•	•	•	•	•	•	•	•	•
221	220 pF	•	•	•	•	•	•	•	•	•	•	•	•	•	•	•
271	270 pF	•	•	•	•	•	•	•	•	•	•	•	•	•	•	•
331	330 pF	•	•		•	•	•	•	•	•	•	•	•	•	•	•
391	390 pF	•	•		•	•	•	•	•	•	•	•	•	•	•	•
471	470 pF	•	•		•	•	•	•	•	•	•	•	•	•	•	•
561	560 pF	•			•	•	•		•	•	•	•	•	•	•	•
681	680 pF	•			•	•	•		•	•	•	•	•	•	•	•
821	820 pF	•			•	•	•		•	•	•	•	•	•	•	•
102	1000 pF	•			•	•	•		•	•	•	•	•	•	•	•
122	1200 pF				•	•			•	•	•		•	•	•	•
152	1500 pF				•	•			•	•	•		•	•	•	•
182	1800 pF				•	•			•	•	•		•	•	•	•
222	2200 pF				•				•	•	•		•	•	•	
272	2700 pF				•				•	•	•		•	•	•	
332	3300 pF				•				•	•	•		•	•	•	
392	3900 pF				•				•	•			•	•	•	
472	4700 pF								•	•			•	•	•	
562	5600 pF								•	•			•	•	•	
682	6800 pF								•	•			•	•	•	
822	8200 pF								•	•			•	•	•	
103	0.010 μF												•	•		
123	0.012 μF												•	•		
153	0.015 μF															
183	0.018 μF															
223	0.022 μF															
273	0.027 μF															
333	0.033 μF															
393	0.039 μF															
473	0.047 μF															
563	0.056 μF															

Note

- See soldering recommendations within this databook, or visit www.vishay.com/doc?45034



SELECTION CHART																							
DIELECTRIC		X7R																					
STYLE		GA0603					GA0805					GA1206					GA1210						
CASE CODE		0603					0805					1206					1210						
VOLTAGE (V _{DC})		16	25	50	100	200	16	25	50	100	200	16	25	50	100	200	500 / 630	16	25	50	100	200	500 / 630
VOLTAGE CODE		J	X	A	B	C	J	X	A	B	C	J	X	A	B	C	E / L	J	X	A	B	C	E / L
CAP. CODE	CAP.																						
103	10 nF	•	•	•	•		•	•	•	•	•	•	•	•	•	•	•	•	•	•	•	•	
123	12 nF	•	•	•	•		•	•	•	•	•	•	•	•	•	•	•	•	•	•	•	•	
153	15 nF	•	•	•	•		•	•	•	•	•	•	•	•	•	•	•	•	•	•	•	•	
183	18 nF	•	•	•	•		•	•	•	•	•	•	•	•	•	•	•	•	•	•	•	•	
223	22 nF	•	•	•	•		•	•	•	•	•	•	•	•	•	•	•	•	•	•	•	•	
273	27 nF	•	•	•	•		•	•	•	•	•	•	•	•	•	•	•	•	•	•	•	•	
333	33 nF	•	•	•	•		•	•	•	•	•	•	•	•	•	•	•	•	•	•	•	•	
393	39 nF	•	•	•	•		•	•	•	•	•	•	•	•	•	•	•	•	•	•	•	•	
473	47 nF	•	•	•	•		•	•	•	•	•	•	•	•	•	•	•	•	•	•	•	•	
563	56 nF	•	•	•	•		•	•	•	•	•	•	•	•	•	•	•	•	•	•	•	•	
683	68 nF	•	•	•	•		•	•	•	•	•	•	•	•	•	•	•	•	•	•	•	•	
823	82 nF	•	•	•	•		•	•	•	•	•	•	•	•	•	•	•	•	•	•	•	•	
104	100 nF	•	•	•	•		•	•	•	•	•	•	•	•	•	•	•	•	•	•	•	•	
124	120 nF	•					•	•	•	•	•	•	•	•	•	•	•	•	•	•	•	•	
154	150 nF	•					•	•	•	•	•	•	•	•	•	•	•	•	•	•	•	•	
184	180 nF						•	•	•	•	•	•	•	•	•	•	•	•	•	•	•	•	
224	220 nF						•	•	•	•	•	•	•	•	•	•	•	•	•	•	•	•	
274	270 nF						•	•	•	•	•	•	•	•	•	•	•	•	•	•	•	•	
334	330 nF						•	•	•	•	•	•	•	•	•	•	•	•	•	•	•	•	
394	390 nF						•	•	•	•	•	•	•	•	•	•	•	•	•	•	•	•	
474	470 nF						•	•	•	•	•	•	•	•	•	•	•	•	•	•	•	•	
564	560 nF																						
684	680 nF																						
824	820 nF																						

Note

- See soldering recommendations within this databook, or visit www.vishay.com/doc?45034



SELECTION CHART										
DIELECTRIC		X8R								
STYLE		GA0603		GA0805			GA1206		GA1210	
CASE CODE		0603		0805			1206		1210	
VOLTAGE (V _{DC})		25	50	25	50	100	25	50	25	50
VOLTAGE CODE		X	A	X	A	B	X	A	X	A
CAP. CODE	CAP.									
103	10 nF	•	•	•	•	•	•	•	•	•
123	12 nF	•	•	•	•	•	•	•	•	•
153	15 nF	•	•	•	•	•	•	•	•	•
183	18 nF	•	•	•	•	•	•	•	•	•
223	22 nF	•		•	•	•	•	•	•	•
273	27 nF	•		•	•	•	•	•	•	•
333	33 nF	•		•	•		•	•	•	•
393	39 nF			•	•		•	•	•	•
473	47 nF			•	•		•	•	•	•
563	56 nF			•	•		•	•	•	•
683	68 nF			•			•	•	•	•
823	82 nF			•			•	•	•	•
104	100 nF			•			•	•	•	•
124	120 nF						•	•	•	•
154	150 nF						•		•	•
184	180 nF						•		•	
224	220 nF						•		•	
274	270 nF									
334	330 nF									
394	390 nF									
474	470 nF									
564	560 nF									
684	680 nF									
824	820 nF									
105	1.0 μF									
125	1.2 μF									

Note

- See soldering recommendations within this databook, or visit www.vishay.com/doc?45034

STANDARD PACKAGING QUANTITIES (1)			
CASE CODE	TAPE SIZE	7" REEL QUANTITIES	11 1/4" AND 13" REEL QUANTITIES
		PLASTIC TAPE PACKAGING CODE "T"	PLASTIC TAPE PACKAGING CODE "R"
0603	8 mm	4000	10 000
0805	8 mm	3000	10 000
1206	8 mm	3000	10 000
1210	8 mm	3000	10 000

Note

(1) Reference: EIA standard RS 481 - "Taping of Surface Mount Components for Automatic Placement"



1 - GENERAL CERTIFICATES

# Quality management system according to ISO/IATF 16949: 2016	Yes
# Quality management system according to ISO 9001: 2015	Yes
# Environmental certification according to ISO 14001: 2015	Yes
# Health and safety system according to ISO 45001	Yes

2 - TECHNICAL REQUIREMENTS

Unless specified in component specification, these parameters are the minimum requirements for the components.

2.1 OPERATING TEMPERATURE RANGE

For standard applications	T _A : -55 °C to +125 °C	See characteristics 2.2
For high temperature applications	T _A : -55 °C to +150 °C	See characteristics 2.2

2.2 CHARACTERISTICS

PARAMETER		CERAMIC TYPE	SYMBOL	RATINGS	TEST CONDITIONS / REMARKS
Rated voltage in temperature range	-55 °C to +125 °C	C0G (NP0)	U _R	50 V to 500 V	
		X7R		16 V to 630 V	
	-55 °C to +150 °C	X8R		25 V to 100 V	
Derating at higher temperature up to +150 °C		C0G (NP0)		50 V to 100 V	U _{DC} ≤ 1/2 U _R
		X7R		16 V to 100 V	U _{DC} ≤ 1/2 U _R U _{DC} ≤ 1/4 U _R for GA0603Y104*A (100 nF / 50 V)
Temperature coefficient in temperature range -55 °C to +125 °C		C0G (NP0)	α _C	≤ ± 30 ppm/°C	Specific ratings can vary, please contact mlcc@vishay.com for details
		X7R	ΔC	≤ ± 15 %	
Temperature coefficient in temperature range -55 °C to +150 °C		C0G (NP0)	α _C	≤ ± 30 ppm/°C	Specific ratings can vary, please contact mlcc@vishay.com for details
		X7R	ΔC	+ 15 % / - 30 %	
		X8R		± 15 %	

2.3 STORAGE AND HANDLING CONDITIONS

<p>(1) Store the components at 5 °C to 40 °C ambient temperature and ≤ 70 % relative humidity conditions.</p> <p>(2) The product is recommended to be used within a time-frame of 2 year after shipment. Check solderability in case extended shelf life beyond the expiry date is needed.</p> <p>Precautions:</p> <p>a. Do not store products in an environment containing corrosive elements, especially where chloride gas, sulfide gas, acid, alkali, salt or the like are present. This may cause corrosion or oxidization of the terminations, which can easily lead to poor soldering.</p> <p>b. Store products on the shelf and avoid exposure to moisture or dust.</p> <p>c. Do not expose products to excessive shock, vibration, direct sunlight and so on.</p>
--



COG (NP0) DIELECTRIC - TYPICAL PARAMETERS

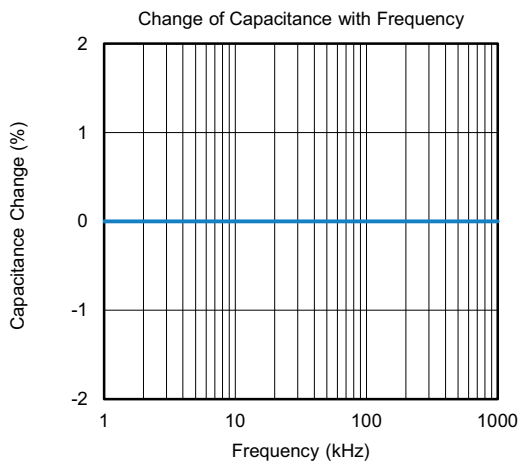
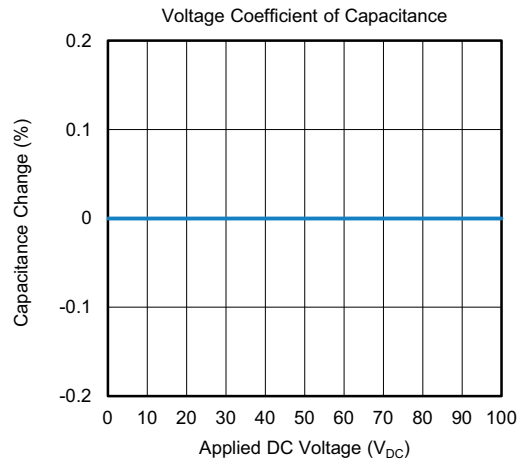
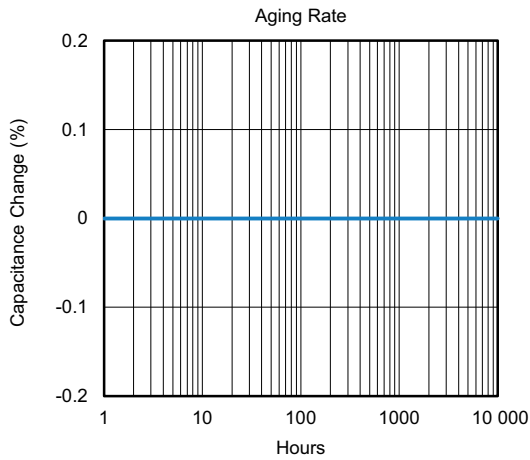
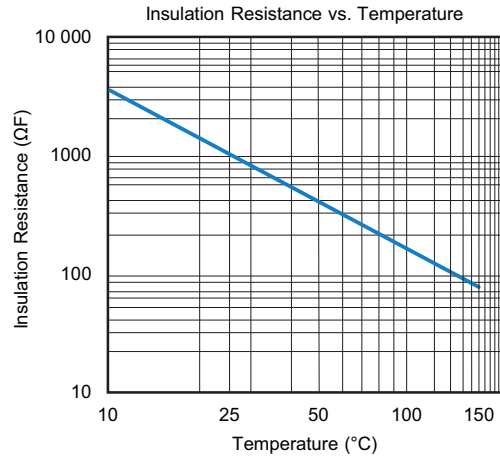
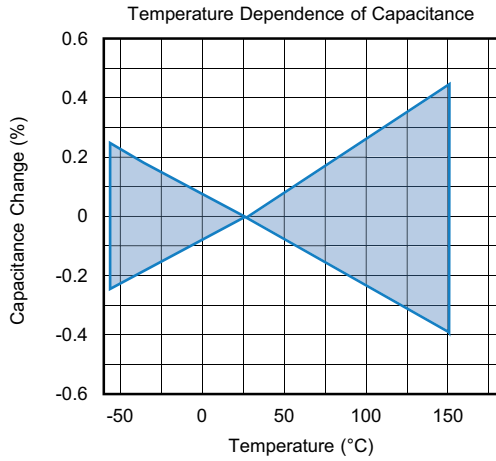



X7R DIELECTRIC - TYPICAL PARAMETERS

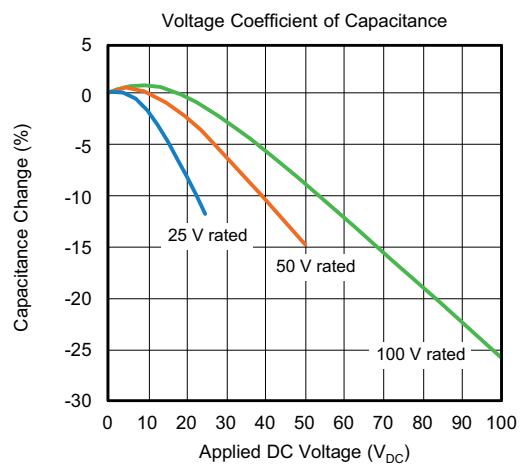
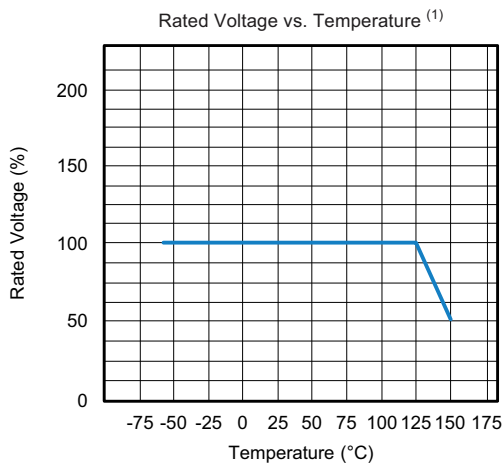
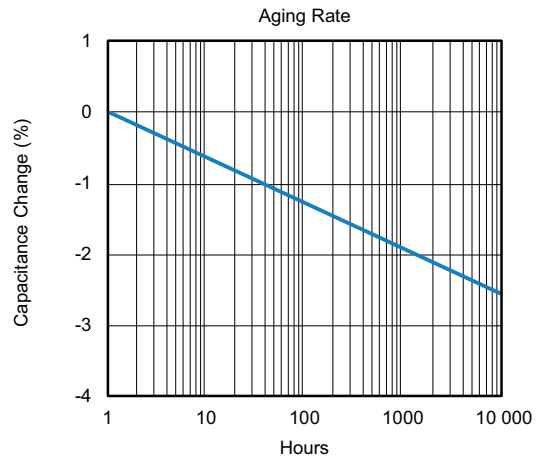
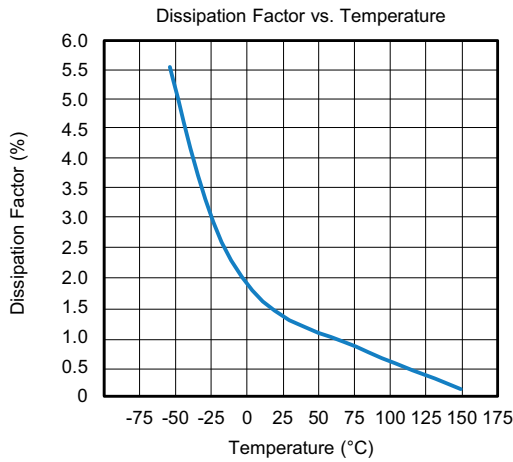
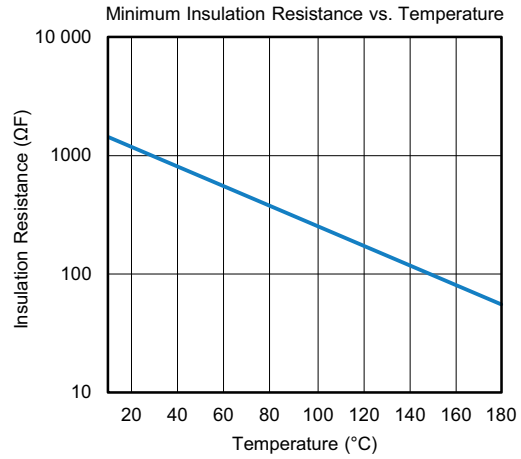
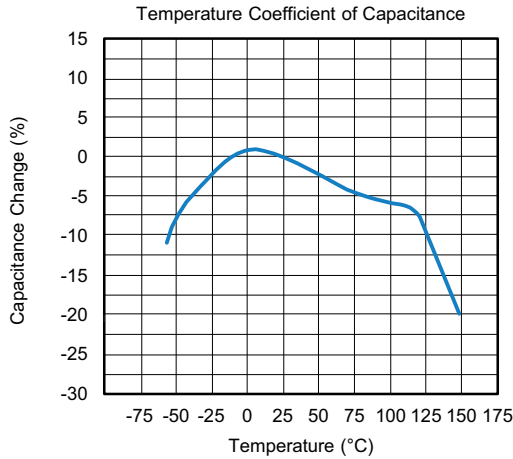

Note

⁽¹⁾ Except for GA0603Y104*A (100 nF / 50 V), see section “2.2 Characteristics”



X7R DIELECTRIC - TYPICAL PARAMETERS

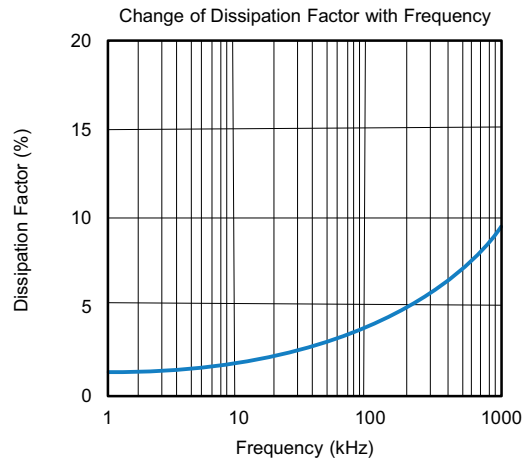
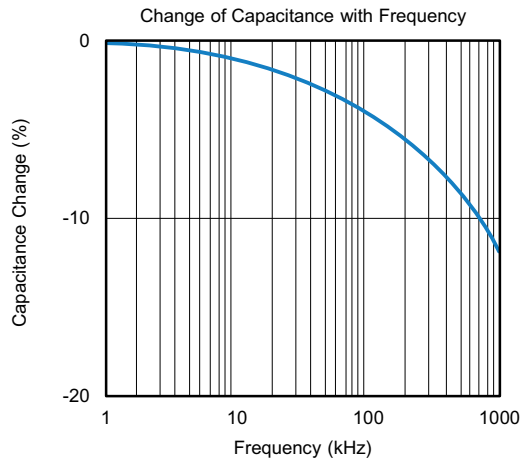
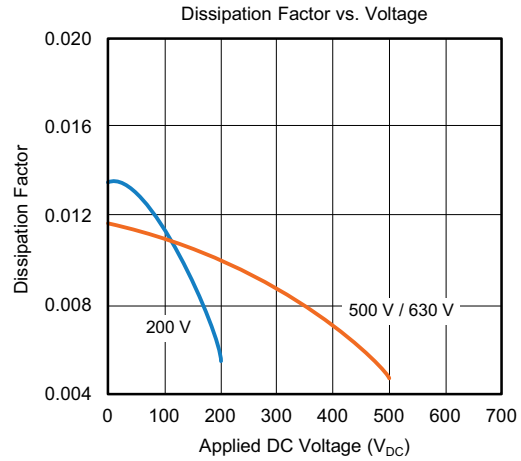
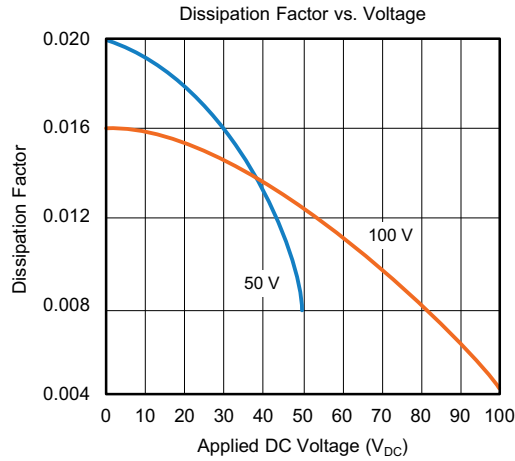



X8R DIELECTRIC - TYPICAL PARAMETERS

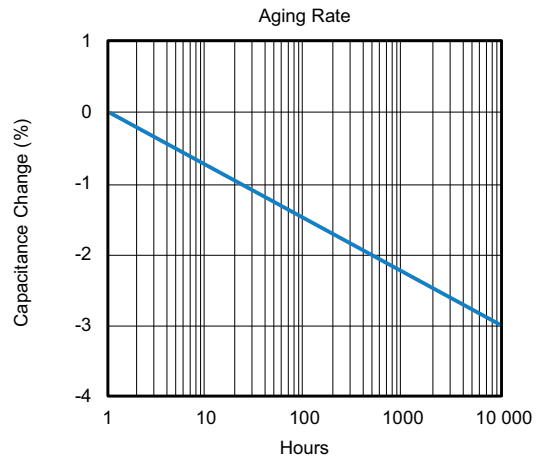
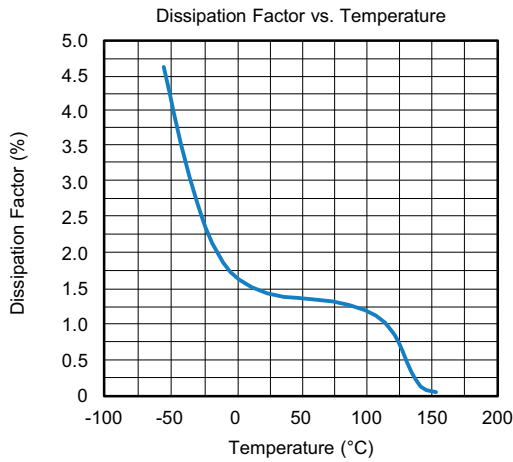
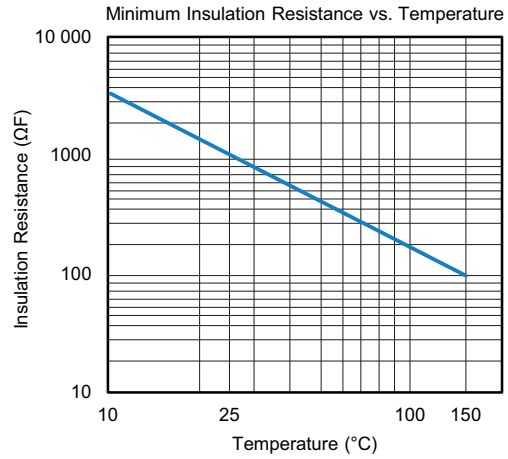
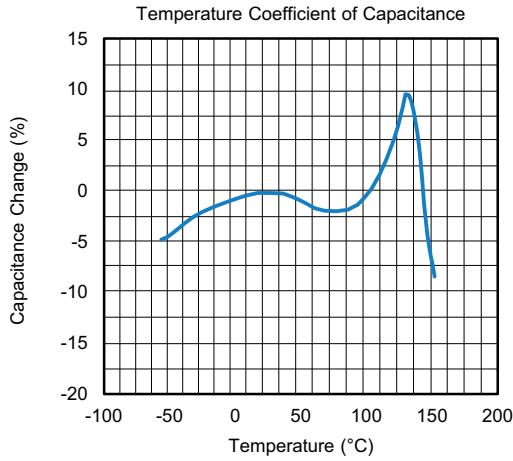



3 - LOT ACCEPTANCE TESTS

Process tests available in classes (on request)

GROUP	ACTION
A	Components are tested within the monitoring program of the supplier. The supplier shall submit the part numbers of the selected component to the customer during the component specification discussions.
B	Components (customer P/N) shall be tested quarterly. Records available only on special request by the customer.
C	Test with each shipment. Records are provided on a monthly basis. Customer special requirement; requirement should be determined in a specific component specification.

Upon request the records can be submitted in electronic format on monthly basis.

3.1 THERMAL STRENGTH, THERMAL SHOCK SENSIBILITY

Sample size	200
Handling	Mounted on PCB
Thermal shock	1 x 280 °C, no pre-heat, 5 s to 10 s
IR - test (IRATS)	U = U _R , T = room temperature, verified
Burn in (BIATS)	Equivalent to 12 h burn-in, 2 x U _R /125 °C, verification time to failure

Acceptance criteria: zero defects (IRATS and BIATS).

3.2 BOARD FLEX TEST

Sample size	20 pcs/lot
Frequency	Each lot
Max. deflection	5 mm

4 - ENVIRONMENTAL REQUIREMENTS

A list of the chemical substances content, which must not be used or whose use shall be limited by international law, is available on request.

Vishay confirms that the components specified in this specification do not contain asbestos nor cadmium, not even in the smallest volumes.

The manufacturer / supplier confirms that the component during normal handling, storage and assembly, as well as during operation in the automobile, is non toxic.

5 - INSPECTION CRITERIA

The supplier shall carry out visual examination with suitable equipment with approximately 10 x magnification and lighting appropriate to the specimen under test and the required quality level.

Chipping

The components shall be free of cracks or fissures. Small damages which do not deteriorate the performance of the component as defined in EIA 595.

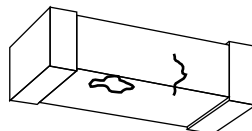

Delamination or Exposed Electrodes

No visible separation or delamination between layers of the capacitor and no exposed electrodes between the two terminals of the capacitor must be seen.

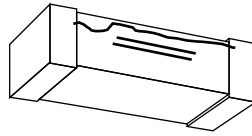

Metallization

For the metallization, no visible detachment of the metallized terminals and no exposed electrodes must be seen. Defects and gaps in the metallization on each sides of the terminal must not exceed 10 % of the total area (e.g. A, B, C, ...) as defined in EIA 595.

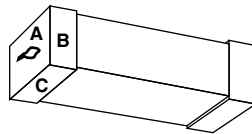

Electrode Distance

The ceramic body shall be free of any conducting material between the terminals which reduces the distance of the electrodes. The minimum distance "D" is 350 µm for all package sizes.

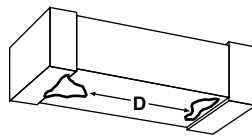

6 - BOARD FLEX TEST CONDITIONS

6.1 BOARD FLEX DEFINITIONS OF TEST

PCB thickness = (1.6 ± 0.1) mm

Copper thickness = 35 µm

Material FR4 (EP-GC 02 according to DIN 40 802)

LAYOUT / PAD DESIGN (Dimensions in mm)			
CASE CODE	PAD SIZE		
	LL	LB	LEL
0603	2.20	1.00	0.75
0805	3.40	1.30	1.20
1206	4.50	1.80	1.20
1210	4.50	2.80	1.30

Note

- LL = total length; LB = width of the pad; LEL = single pad length

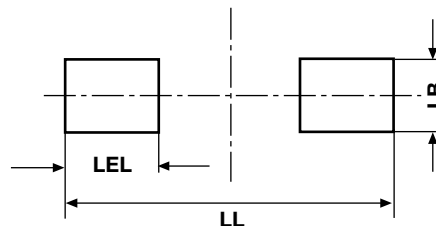

6.2 SOLDERING INSTRUCTIONS

THICKNESS, RECOMMENDED FOR SOLDER PASTE (Reflow soldering)	
CASE CODE	THICKNESS in μm
0603	150 to 200
0805	150 to 200
1206	150 to 200
1210	150 to 200

6.3 TYPICAL TEMPERATURE PROFILE FOR REFLOW SOLDERING (Boardflex test)

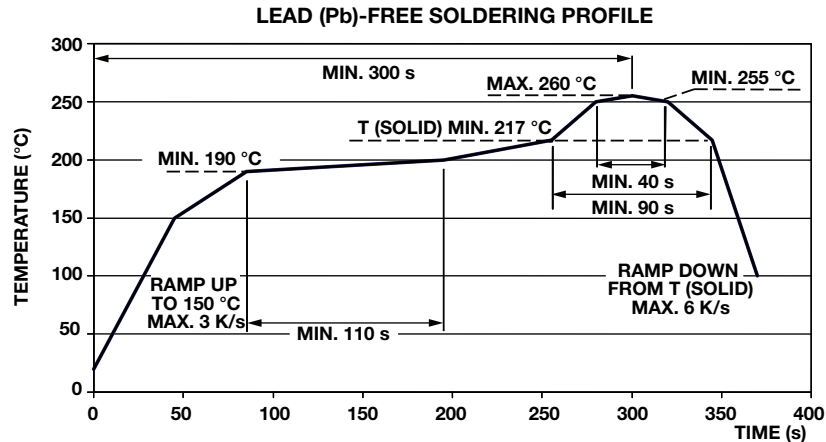

6.4 MOUNTING, DIMENSIONS, AND TESTING

Mounting

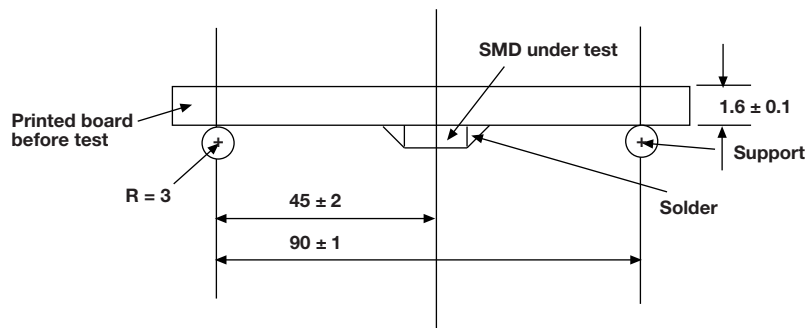

Testing

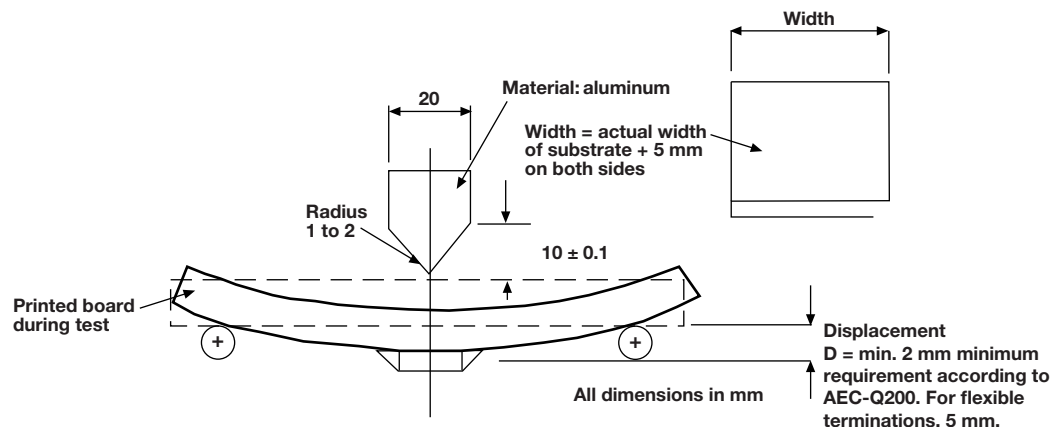



6.5 PERFORMANCE OF THE TEST(S)

- A) Electrical test according to component specification (Cap, DF, IR)
- B) Mounting to PCB
- C) Storage at room temperature (min. 10 h)
- D) Board flex test - bending to the required bending depth (5 mm) with a speed of 1 mm/s and a hold time of 5 s

6.6 DETAILS

X8R	PCB to be deflected up to 5 mm. Parametric testing (capacitance) after each step to detect eventual development of cracks
X7R	PCB to be deflected up to 5 mm. Parametric testing (capacitance) after each step to detect eventual development of cracks
C0G	PCB to be deflected up to 5 mm. Parametric testing (capacitance) after each step to detect eventual development of cracks

6.7 FAILURE CRITERIA

X8R	Board flex JIS-6429, AEC-Q200-005, no failure. Board flex (5 mm typical) 5 % ΔC/C
X7R	Board flex JIS-6429, AEC-Q200-005, no failure. Board flex (5 mm typical) 5 % ΔC/C
C0G	Board flex JIS-6429, AEC-Q200-005, no failure. Board flex (5 mm typical) 5 % ΔC/C
All	Electrical test according to component specification

7 - AEC-Q200 QUALIFICATION TESTING

NO.	AEC-Q200 TEST ITEM	REFERENCE
1	Pre- and post stress electrical test	User spec
3	High temp exposure (storage)	MIL-STD-202, method 108
4	Temperature cycling	JESD22, method JA-104
5	Destructive physical analysis	EIA-469
6	Moisture resistance	MIL-STD-202, method 106
7	Biased humidity	MIL-STD-202, method 103
8	Operation life	MIL-STD-202 method 108
9	External Visual	MIL-STD-883 method 2009
10	Physical dimension	JESD22, method JB-100
13	Mechanical shock	MIL-STD-202, method 213
14	Vibration	MIL-STD-202, method 204
15	Resistance to solder heat	MIL-STD-202, method 210
16	ESD	AEC-Q200-002
17	Solderability	J-STD-002
20	Electrical characterization	User spec
21	Board flex	AEC-Q200-005
22	Terminal strength	AEC-Q200-006
23	Beam load	AEC-Q200-003



Disclaimer

ALL PRODUCT, PRODUCT SPECIFICATIONS AND DATA ARE SUBJECT TO CHANGE WITHOUT NOTICE TO IMPROVE RELIABILITY, FUNCTION OR DESIGN OR OTHERWISE.

Vishay Intertechnology, Inc., its affiliates, agents, and employees, and all persons acting on its or their behalf (collectively, "Vishay"), disclaim any and all liability for any errors, inaccuracies or incompleteness contained in any datasheet or in any other disclosure relating to any product.

Vishay makes no warranty, representation or guarantee regarding the suitability of the products for any particular purpose or the continuing production of any product. To the maximum extent permitted by applicable law, Vishay disclaims (i) any and all liability arising out of the application or use of any product, (ii) any and all liability, including without limitation special, consequential or incidental damages, and (iii) any and all implied warranties, including warranties of fitness for particular purpose, non-infringement and merchantability.

Statements regarding the suitability of products for certain types of applications are based on Vishay's knowledge of typical requirements that are often placed on Vishay products in generic applications. Such statements are not binding statements about the suitability of products for a particular application. It is the customer's responsibility to validate that a particular product with the properties described in the product specification is suitable for use in a particular application. Parameters provided in datasheets and / or specifications may vary in different applications and performance may vary over time. All operating parameters, including typical parameters, must be validated for each customer application by the customer's technical experts. Product specifications do not expand or otherwise modify Vishay's terms and conditions of purchase, including but not limited to the warranty expressed therein.

Hyperlinks included in this datasheet may direct users to third-party websites. These links are provided as a convenience and for informational purposes only. Inclusion of these hyperlinks does not constitute an endorsement or an approval by Vishay of any of the products, services or opinions of the corporation, organization or individual associated with the third-party website. Vishay disclaims any and all liability and bears no responsibility for the accuracy, legality or content of the third-party website or for that of subsequent links.

Except as expressly indicated in writing, Vishay products are not designed for use in medical, life-saving, or life-sustaining applications or for any other application in which the failure of the Vishay product could result in personal injury or death. Customers using or selling Vishay products not expressly indicated for use in such applications do so at their own risk. Please contact authorized Vishay personnel to obtain written terms and conditions regarding products designed for such applications.

No license, express or implied, by estoppel or otherwise, to any intellectual property rights is granted by this document or by any conduct of Vishay. Product names and markings noted herein may be trademarks of their respective owners.